



European Centre  
for Soft Computing

# Genetic Fuzzy Systems

**Fuzzy Knowledge Extraction by Evolutionary Algorithms**

Oscar Cordón

Mieres, 9-13 July 2007

1. Brief introduction to genetic fuzzy systems
2. The birth of GFSs: 1991. GFSs roadmap and milestones
3. Evolutionary tuning of fuzzy rule-based systems
4. Classical GFS learning approaches
5. Some real-world applications
6. Advanced GFS approaches
7. Conclusions. What's next?

# 1. Brief introduction to genetic fuzzy systems

## OUTLINE

### 1. Introduction to GFSs

2. GFSs roadmap and milestones

3. Evolutionary tuning of FRBSs

4. Classical GFS learning approaches

5. Some real-world applications

6. Advanced GFS approaches

7. Conclusions. What's next?

- The use of genetic/evolutionary algorithms (GAs) to design fuzzy systems constitutes one of the branches of the **Soft Computing** paradigm: **genetic fuzzy systems** (GFSs)
- The most known approach is that of **genetic fuzzy rule-based systems**, where some components of a fuzzy rule-based system (FRBS) are derived (**adapted or learnt**) using a GA
- Some other approaches include genetic fuzzy neural networks and genetic fuzzy clustering, among others

# 1. Brief introduction to genetic fuzzy systems

## OUTLINE

1. Introduction to GFSs
2. GFSs roadmap and milestones
3. Evolutionary tuning of FRBSs
4. Classical GFS learning approaches
5. Some real-world applications
6. Advanced GFS approaches
7. Conclusions. What's next?

## GFSs and Soft Computing:

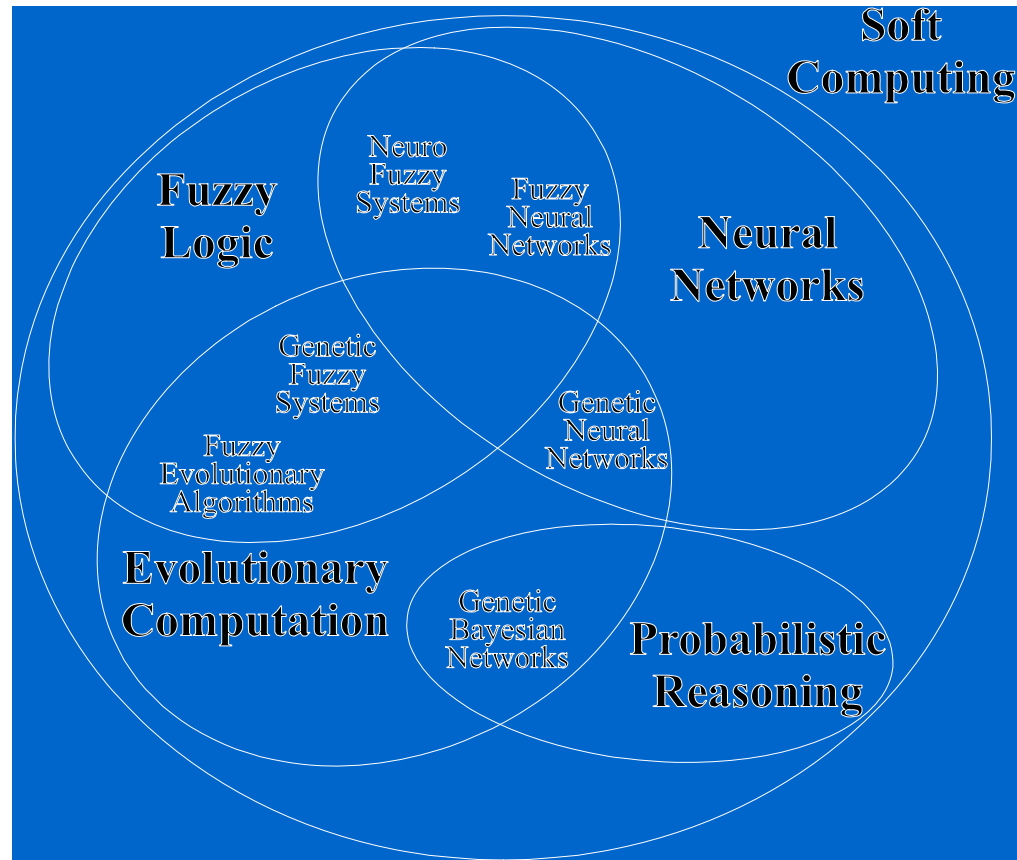

# 1. Brief introduction to genetic fuzzy systems

## OUTLINE

1. Introduction to GFSs
2. GFSs roadmap and milestones
3. Evolutionary tuning of FRBSs
4. Classical GFS learning approaches
5. Some real-world applications
6. Advanced GFS approaches
7. Conclusions. What's next?

## Evolutionary algorithms and machine learning:

- Evolutionary algorithms were not specifically designed as machine learning techniques, like other approaches like neural networks
- However, it is well known that a learning task can be modelled as an optimization problem, and thus solved through evolution
- Their powerful search in complex, ill-defined problem spaces has permitted applying evolutionary algorithms successfully to a huge variety of machine learning and knowledge discovery tasks
- Their flexibility and capability to incorporate existing knowledge are also very interesting characteristics for the problem solving.

# 1. Brief introduction to genetic fuzzy systems

## OUTLINE

1. Introduction to GFSs
2. GFSs roadmap and milestones
3. Evolutionary tuning of FRBSs
4. Classical GFS learning approaches
5. Some real-world applications
6. Advanced GFS approaches
7. Conclusions. What's next?

## Genetic Fuzzy Rule-Based Systems:

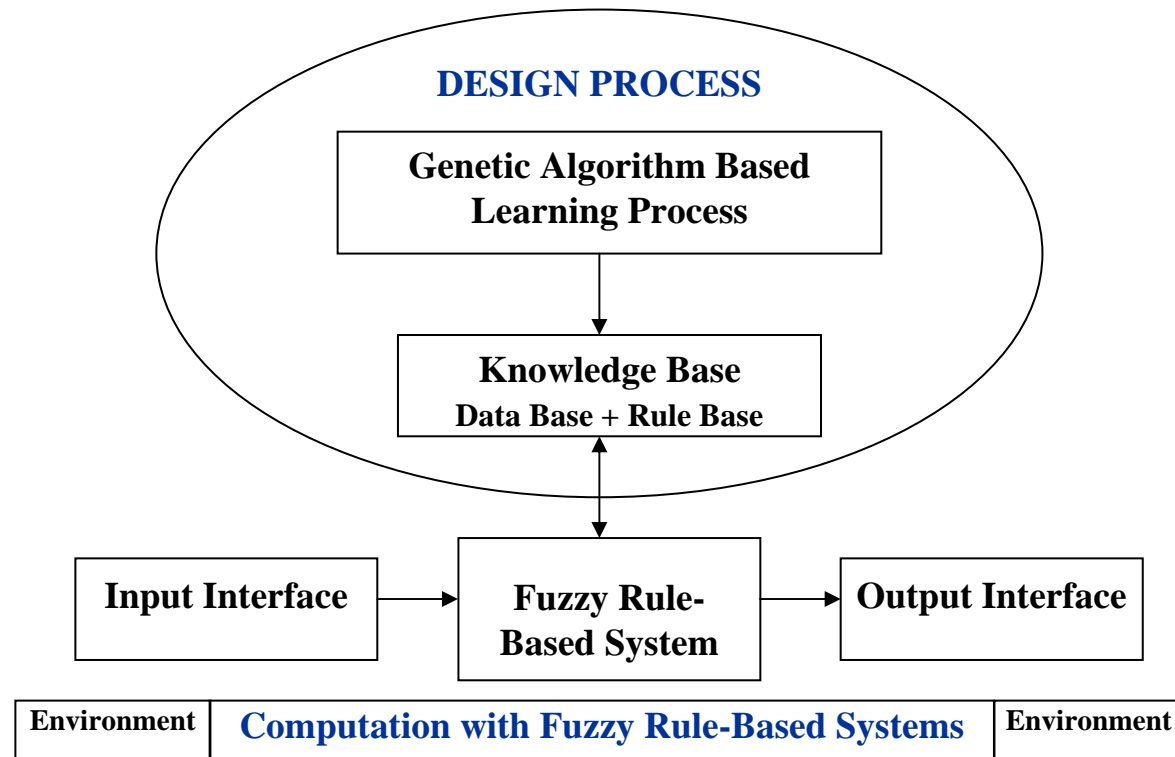

# 1. Brief introduction to genetic fuzzy systems

## OUTLINE

### 1. Introduction to GFSs

2. GFSs roadmap and milestones

3. Evolutionary tuning of FRBSs

4. Classical GFS learning approaches

5. Some real-world applications

6. Advanced GFS approaches

7. Conclusions. What's next?

## Design of fuzzy rule-based systems:

- An FRBS (regardless it is a fuzzy model, a fuzzy logic controller or a fuzzy classifier), is comprised by two main components:
  - The **Knowledge Base (KB)**, storing the available problem knowledge in the form of fuzzy rules
  - The **Inference System**, applying a fuzzy reasoning method on the inputs and the KB rules to give a system output
- Both must be designed to build an FRBS for a specific application:
  - The KB is obtained from expert knowledge or by machine learning methods
  - The Inference System is set up by choosing the fuzzy operator for each component (conjunction, implication, defuzzifier, etc.)  
**Sometimes, the latter operators are also parametric and can be tuned using automatic methods**

# 1. Brief introduction to genetic fuzzy systems

## OUTLINE

### 1. Introduction to GFSs

2. GFSs roadmap and milestones

3. Evolutionary tuning of FRBSs

4. Classical GFS learning approaches

5. Some real-world applications

6. Advanced GFS approaches

7. Conclusions. What's next?

The KB design involves two subproblems, related to its two subcomponents:

- Definition of the **Data Base (DB)**:
  - Variable universes of discourse
  - Scaling factors or functions
  - Granularity (number of linguistic terms/labels) per variable
  - Membership functions associated to the labels
- Derivation of the **Rule Base (RB)**: fuzzy rule composition

As said, there are two different ways to design the KB:

- From **human expert** information
- By means of **machine learning methods** guided by the existing **numerical information** (fuzzy modeling and classification) or by a model of the system being controlled





# 1. Brief introduction to genetic fuzzy systems

## OUTLINE

1. Introduction to GFSs
2. GFSs roadmap and milestones
3. Evolutionary tuning of FRBSs
4. Classical GFS learning approaches
5. Some real-world applications
6. Advanced GFS approaches
7. Conclusions. What's next?

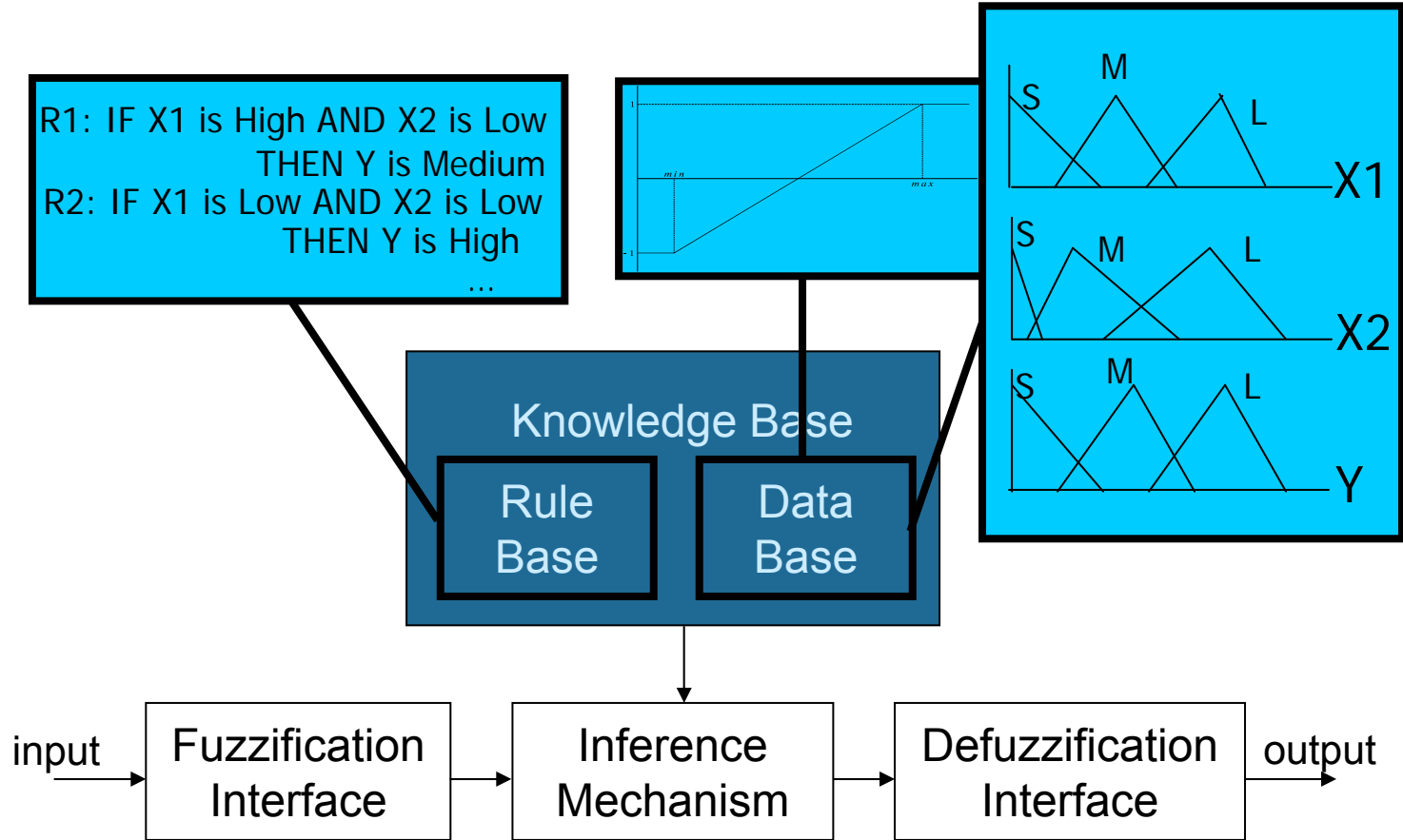

## Fuzzy rule-based system

# 1. Brief introduction to genetic fuzzy systems

## OUTLINE

1. Introduction to GFSs
2. GFSs roadmap and milestones
3. Evolutionary tuning of FRBSs
4. Classical GFS learning approaches
5. Some real-world applications
6. Advanced GFS approaches
7. Conclusions. What's next?

## Classical Taxonomy of GFRBSs:

There are there different groups of GFRBSs according to the KB components, DB and/or RB, included in the learning process:

- Genetic definition of the FRBS Data Base
- Genetic derivation of the FRBS Rule Base
- Genetic derivation of the FRBS Knowledge Base

Additionally:

- Genetic design of the Inference Mechanism (**less usual**)



# 1. Brief introduction to genetic fuzzy systems

## OUTLINE

- 1. Introduction to GFSs
- 2. GFSs roadmap and milestones
- 3. Evolutionary tuning of FRBSs
- 4. Classical GFS learning approaches
- 5. Some real-world applications
- 6. Advanced GFS approaches
- 7. Conclusions. What's next?

## 1. Genetic definition of the Data Base:

Classically:

- performed on a predefined DB definition
- **tuning** of the membership function shapes by a GA

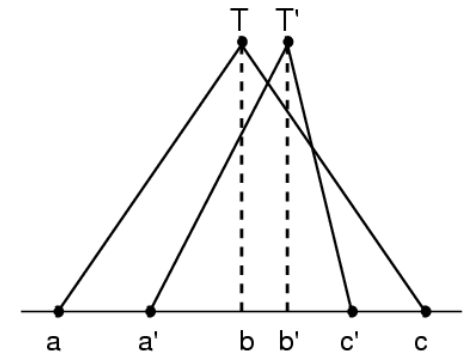
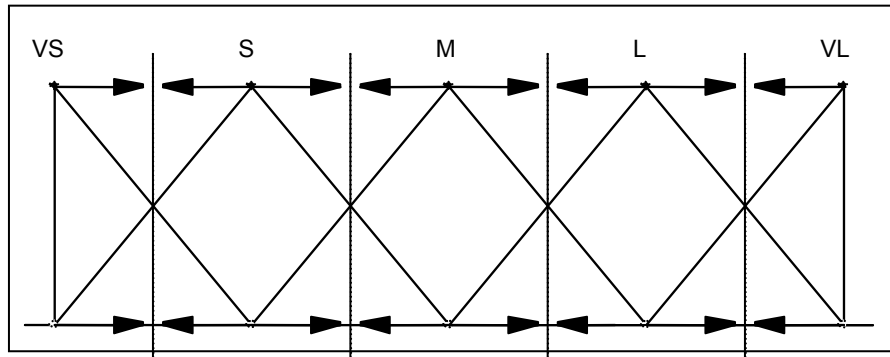



# 1. Brief introduction to genetic fuzzy systems

## OUTLINE

1. Introduction to GFSs
2. GFSs roadmap and milestones
3. Evolutionary tuning of FRBSs
4. Classical GFS learning approaches
5. Some real-world applications
6. Advanced GFS approaches
7. Conclusions. What's next?

## 2. Genetic Derivation of the Rule Base:

- A predefined Data Base definition is assumed
- The fuzzy rules (usually Mamdani-type) are derived by a GA

$X_2 \backslash X_1$	<b>P</b>	<b>M</b>	<b>G</b>
<b>P</b>		S <sub>1</sub> B <sub>1</sub>	
<b>M</b>	S <sub>2</sub> B <sub>2</sub>	S <sub>3</sub> B <sub>2</sub>	
<b>G</b>			S <sub>4</sub> B <sub>3</sub>



### Rule Base

$R_1$	= IF $X_1$ is <b>M</b> and $X_2$ is <b>P</b>	THEN	Y is <b>B<sub>1</sub></b>
$R_2$	= IF $X_1$ is <b>P</b> and $X_2$ is <b>M</b>	THEN	Y is <b>B<sub>2</sub></b>
$R_3$	= IF $X_1$ is <b>M</b> and $X_2$ is <b>M</b>	THEN	Y is <b>B<sub>2</sub></b>
$R_4$	= IF $X_1$ is <b>G</b> and $X_2$ is <b>G</b>	THEN	Y is <b>B<sub>3</sub></b>

# 1. Brief introduction to genetic fuzzy systems

## OUTLINE

1. Introduction to GFSs
2. GFSs roadmap and milestones
3. Evolutionary tuning of FRBSs
4. Classical GFS learning approaches
5. Some real-world applications
6. Advanced GFS approaches
7. Conclusions. What's next?

## 3. Genetic Derivation of the Knowledge Base:

- The simultaneous derivation properly addresses the **strong dependency** existing between the RB and the DB

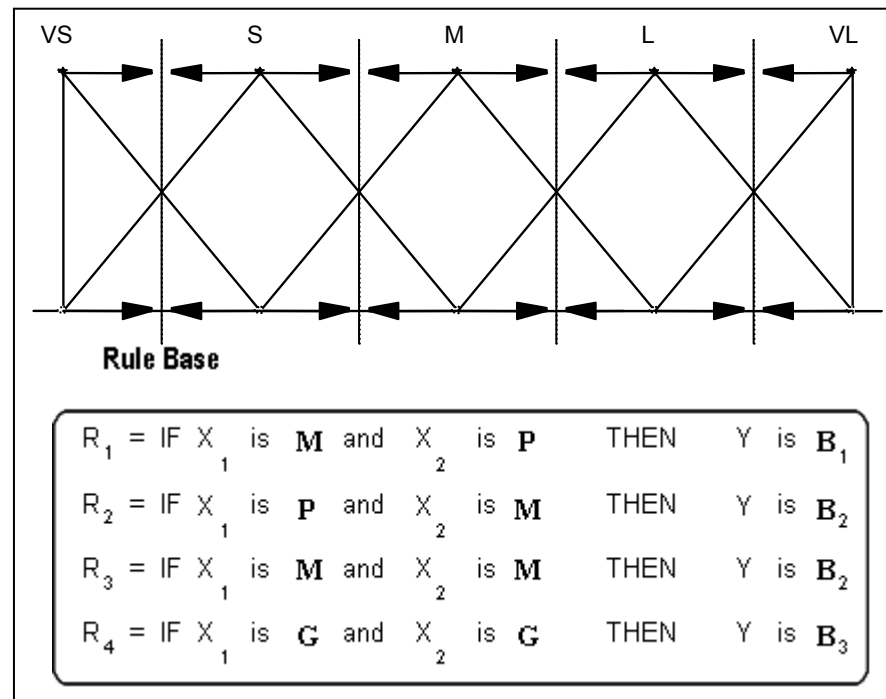

# 1. Brief introduction to genetic fuzzy systems

## OUTLINE

1. Introduction to GFSs
2. GFSs roadmap and milestones
3. Evolutionary tuning of FRBSs
4. Classical GFS learning approaches
5. Some real-world applications
6. Advanced GFS approaches
7. Conclusions. What's next?

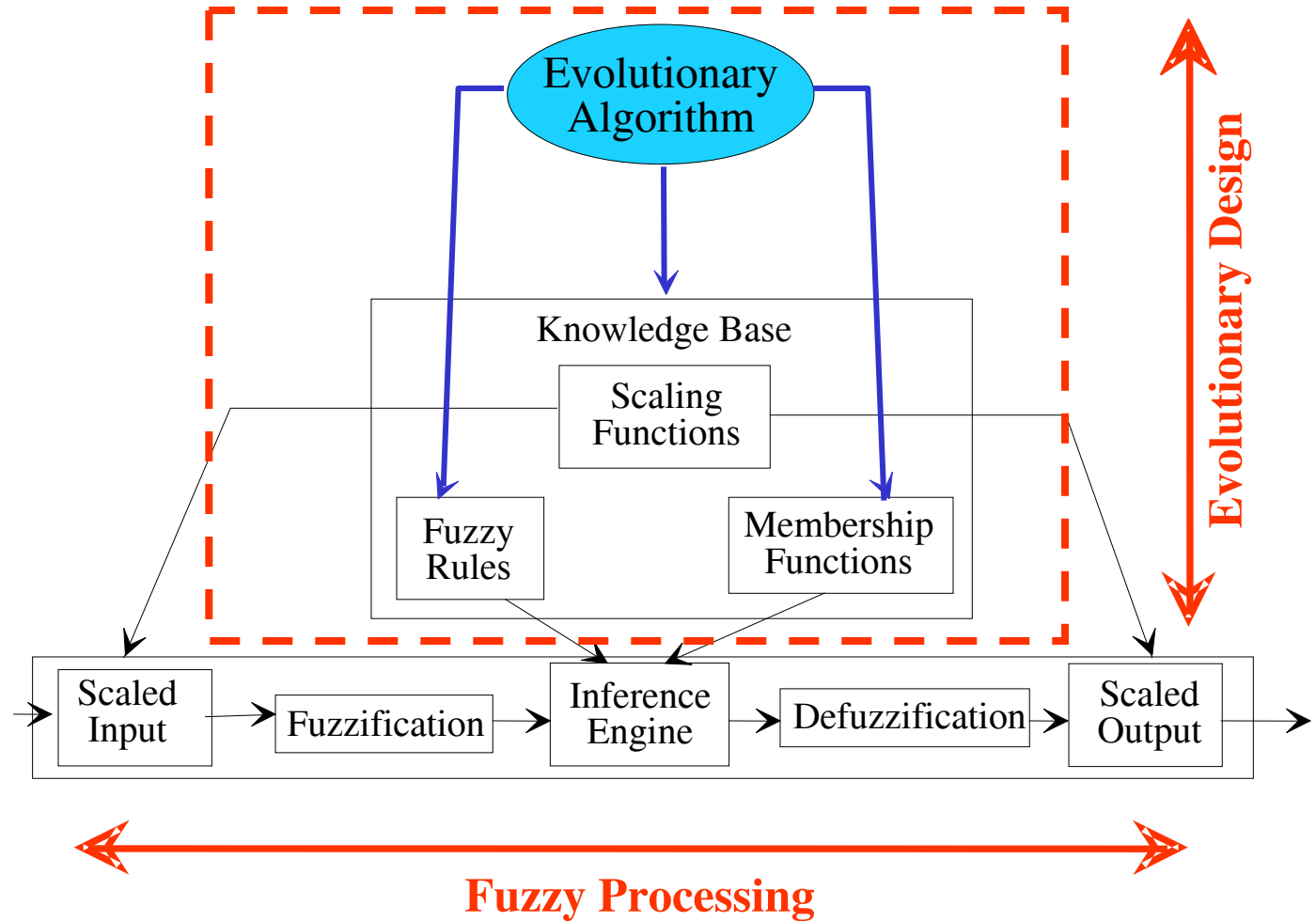

# 1. Brief introduction to genetic fuzzy systems

## OUTLINE

1. Introduction to GFSs
2. GFSs roadmap and milestones
3. Evolutionary tuning of FRBSs
4. Classical GFS learning approaches
5. Some real-world applications
6. Advanced GFS approaches
7. Conclusions. What's next?

## References:

### GENETIC FUZZY SYSTEMS Evolutionary Tuning and Learning of Fuzzy Knowledge Bases.

O. Cordón, F. Herrera, F. Hoffmann, L. Magdalena  
World Scientific, July 2001

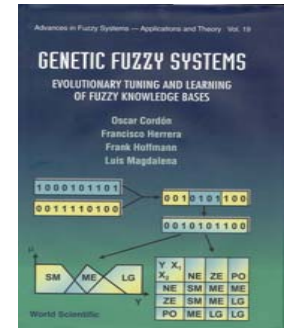

- F. Herrera, Genetic Fuzzy Systems: Status, Critical Considerations and Future Directions, International Journal of Computational Intelligence Research 1 (1) (2005) 59-67
- O. Cordón, F. Gomide, F. Herrera, F. Hoffmann, L. Magdalena, Ten Years of Genetic Fuzzy Systems: Current Framework and New Trends, FSS 141 (1) (2004) 5-31
- F. Hoffmann, Evolutionary Algorithms for Fuzzy Control System Design, Proceedings of the IEEE 89 (9) (2001) 1318-1333

# 2. The birth of GFSs: 1991

## OUTLINE

1. Introduction to GFSs

2. GFSs roadmap and milestones

3. Evolutionary tuning of FRBSs

4. Classical GFS learning approaches

5. Some real-world applications

6. Advanced GFS approaches

7. Conclusions. What's next?

- Thrift's ICGA91 paper (Mamdani-type Rule Base Learning. **Pittsburgh** approach)
- Valenzuela-Rendón's PPSN-I paper (Scatter Mamdani-type KB Learning. **Michigan** approach)
- Pham and Karaboga's Journal of Systems Engineering paper (Relational matrix-based FRBS learning. **Pittsburgh** approach)
- Karr's AI Expert paper (Mamdani-type Data Base **Tuning**)

Almost the whole basis of the area were established in the first year!



# 2. GFSs roadmap

## OUTLINE

1. Introduction to GFSs
2. GFSs roadmap and milestones
3. Evolutionary tuning of FRBSs
4. Classical GFS learning approaches
5. Some real-world applications
6. Advanced GFS approaches
7. Conclusions. What's next?

## 1991-1996/7: INITIAL GFS SETTING: KB LEARNING:

- Establishment of the three classical learning approaches in the GFS field: Michigan, Pittsburgh, and IRL
- Different FRBS types: Mamdani, Mamdani DNF, Scatter Mamdani, TSK
- Generic applications: Classification, Modeling, and Control

## 1995-....: FUZZY SYSTEM TUNING:

- First: Membership function parameter tuning
- Later: other DB components adaptation: scaling factors, context adaptation (scaling functions), linguistic hedges, ...
- Recently: **interpretability consideration**

## OUTLINE

1. Introduction to GFSs

2. GFSs roadmap and milestones

3. Evolutionary tuning of FRBSs

4. Classical GFS learning approaches

5. Some real-world applications

6. Advanced GFS approaches

7. Conclusions. What's next?

## 1998-...: APPROACHING TO MATURITY? NEW GFS LEARNING APPROACHES:

- New EAs: Bacterial genetics, DNA coding, Virus-EA, genetic local search (memetic algorithms), ...
- Hybrid learning approaches: a priori DB learning, GFNNs, Michigan-Pitt hybrids, ...
- Multiobjective evolutionary algorithms
- **Interpretability-accuracy trade-off** consideration
- Course of dimensionality (handling large data sets and complex problems):
  - Rule selection (1995-...)
  - Feature selection at global level and fuzzy rule level
  - Hierarchical fuzzy modeling
- "Incremental" learning

# 2. GFSs roadmap

## OUTLINE

1. Introduction to GFSs
2. GFSs roadmap and milestones
3. Evolutionary tuning of FRBSs
4. Classical GFS learning approaches
5. Some real-world applications
6. Advanced GFS approaches
7. Conclusions. What's next?

## GLOBAL GFS EVOLUTION SNAPSHOT:

From:	To:
Binary coding	Real coding
Simple/basic EAs	Sophisticated EAs
Accuracy-driven GFSs	Accuracy-interpretability trade-off in GFSs
Single-objective optimization	Multi-objective optimization
Strict GFRBS structures	Relaxed GFS structures: <ul style="list-style-type: none"><li>• Fuzzy logic for knowledge representation and reasoning</li><li>• EAs for learning and tuning fuzzy models</li></ul>
Small data sets – simple problems	Large data sets (DM applications) and complex problems <b>??????</b>

# 2. GFSs milestones

## OUTLINE

1. Introduction to GFSs

2. GFSs roadmap and milestones

3. Evolutionary tuning of FRBSs

4. Classical GFS learning approaches

5. Some real-world applications

6. Advanced GFS approaches

7. Conclusions. What's next?

- 1991: four pioneering papers
- 1995: Geyer-Schulz's book: "Fuzzy Rule-Based Expert Systems and Genetic Machine Learning". Physica-Verlag
  - First GFSs book. Very specific: fuzzy classifier systems (Michigan approach) and RB learning with genetic programming
- 1996: Herrera and Verdegay's edited book "Genetic Algorithms and Soft Computing". Physica-Verlag
- 1997:
  - Sanchez, Shibata and Zadeh's edited book "Genetic Algorithms and Fuzzy Logic Systems. Soft Computing Perspectives". World Scientific
  - Pedrycz's edited book "Fuzzy Evolutionary Computation". Kluwer
  - Herrera's special issue on "GFSs for Control and Robotics", IJAR 17:4
  - Herrera and Magdalena's two special sessions on "GFSs" at IFSA'97
- 1998: Herrera and Magdalena's special issue on "GFSs", IJIS 13:10-11

# 2. GFSs milestones

## OUTLINE

1. Introduction to GFSs

2. GFSs roadmap and milestones

3. Evolutionary tuning of FRBSs

4. Classical GFS learning approaches

5. Some real-world applications

6. Advanced GFS approaches

7. Conclusions. What's next?

- 2000: Cordon and Herrera's two special sessions on "GFSs: Issues and Applications" at IPMU'2000
- 2001:
  - Cordon-Herrera-Hoffmann-Magdalena's book on "GFSs. Evolutionary Tuning and Learning of Fuzzy Knowledge Bases", World Scientific  
First general GFSs book, covering the overall state of the art of GFSs by that time
  - 2001: Cordon-Herrera-Hoffmann-Magdalena's special issue on "Recent Advances in GFSs", Information Science 136:1-4
  - 2001: Cordon-Gomide-Herrera-Hoffmann-Magdalena's minitrack on "GFSs: New Developments" at Joint IFSA-NAFIPS
- 2002: Angelov's book "Evolving Rule-Based Models. A Tool for Design of Flexible Adaptive Systems". Physica-Verlag
- 2003: Carse-Pipe's two special sessions on "Evolutionary Fuzzy Systems" at EUSFLAT'2003

# 2. GFSs milestones

## OUTLINE

1. Introduction to GFSs

2. GFSs roadmap and milestones

3. Evolutionary tuning of FRBSs

4. Classical GFS learning approaches

5. Some real-world applications

6. Advanced GFS approaches

7. Conclusions. What's next?

- 2004: Cordon-Gomide-Herrera-Hoffmann-Magdalenas special issue on "GFSs: New Developments", FSS 141:1
  - Position paper from the editors: "Ten years of GFSs: current framework and new trends". 35 citations (June 2007)
- 2005:
  - Carse-Casillas-Pipe's three special sessions on "Evolutionary Fuzzy Systems: Models and Applications" at EUSFLAT'2005
  - Ishibuchi-Nakashima-Nii's book on "Classification And Modeling With Linguistic Information Granules: Advanced Approaches To Linguistic Data Mining", Springer
  - **First International Workshop on GFSs. Granada (Spain)**
- 2006-...:
  - 2 workshops (EFS'06, GEFS'08)
  - 4 special issues (IJAR, IJIS, IEEE TFS, Soft Computing)
  - 6 special sessions (WCCI'06, FuzzIEEE2007), ...

# 3. Evolutionary Tuning of FRBSs

## OUTLINE

1. Introduction to GFSs
2. GFSs roadmap and milestones
3. Evolutionary tuning of FRBSs
4. Classical GFS learning approaches
5. Some real-world applications
6. Advanced GFS approaches
7. Conclusions. What's next?

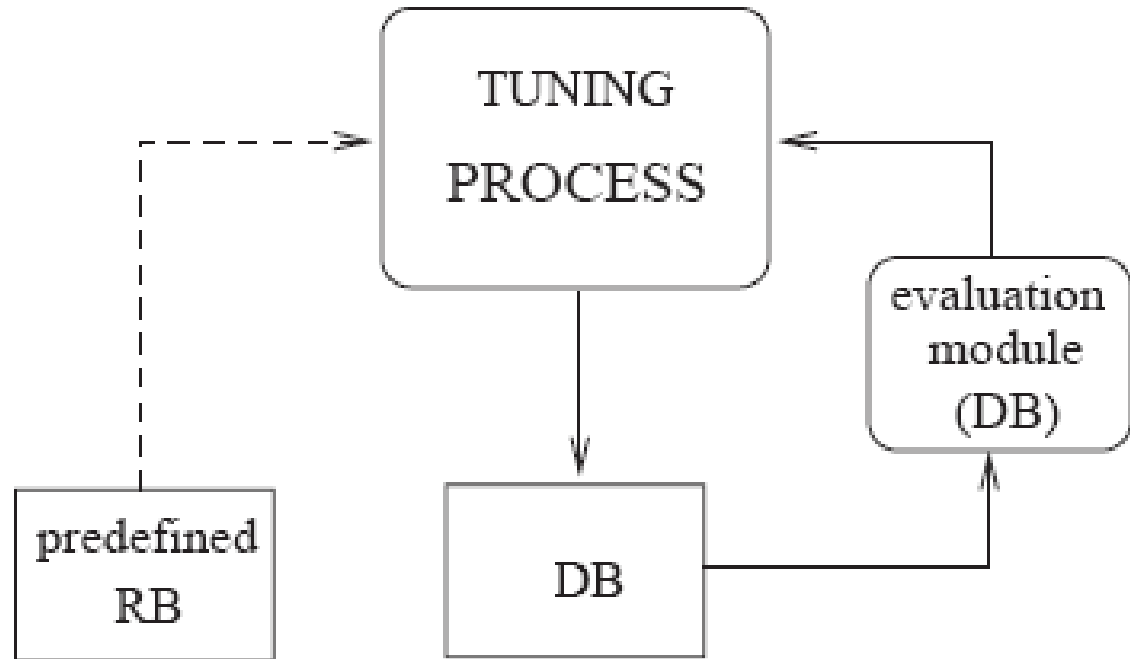

## Evolutionary Data Base Tuning

1. Tuning of scaling functions
2. Tuning of membership functions

# 3. Evolutionary Tuning of FRBSs

## OUTLINE

1. Introduction to GFSs
2. GFSs roadmap and milestones
- 3. Evolutionary tuning of FRBSs**
4. Classical GFS learning approaches
5. Some real-world applications
6. Advanced GFS approaches
7. Conclusions. What's next?

## 1. Tuning of scaling functions

- They apply the universes of discourse of the input and output variables to the domain where the fuzzy sets are defined
- Their adaptation allows the scaled universe of discourse to match the variable range in a better way
- Definition parameters:
  - Scaling factor
  - Upper and lower bounds (linear scaling function)
  - Contraction/dilation parameters (non linear scaling function)
- Coding scheme: fixed length real-coded chromosome

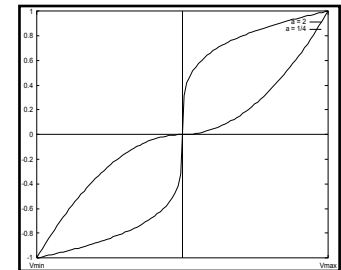
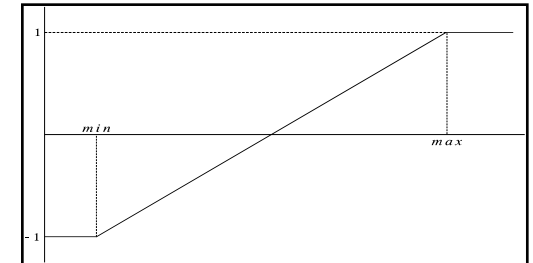



# 3. Evolutionary Tuning of FRBSs

## OUTLINE

1. Introduction to GFSs
2. GFSs roadmap and milestones
3. Evolutionary tuning of FRBSs
4. Classical GFS learning approaches
5. Some real-world applications
6. Advanced GFS approaches
7. Conclusions. What's next?

- Especially useful for fuzzy control applications, where the scaling function represents the gain from a control viewpoint

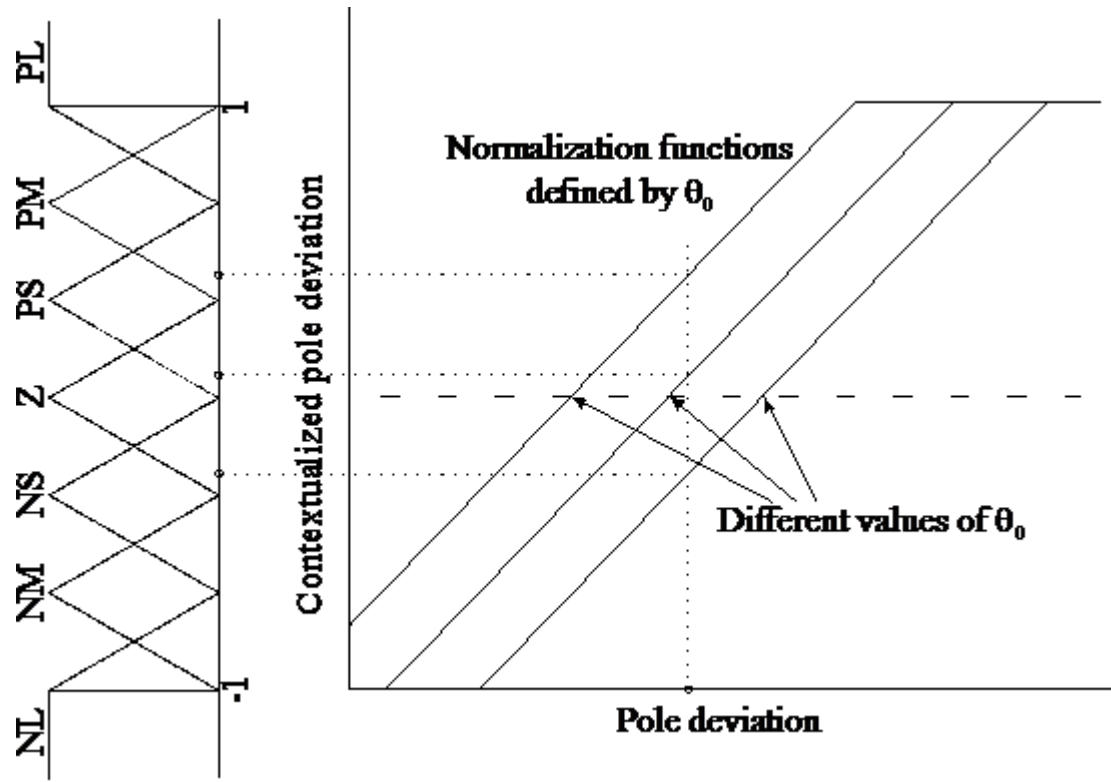

# 3. Evolutionary Tuning of FRBSs

## OUTLINE

1. Introduction to GFSs
2. GFSs roadmap and milestones
- 3. Evolutionary tuning of FRBSs**
4. Classical GFS learning approaches
5. Some real-world applications
6. Advanced GFS approaches
7. Conclusions. What's next?

## References:

- K.C. Ng, Y. Li, Design of sophisticated fuzzy logic controllers using genetic algorithms, in Proc. 3rd IEEE Intl. Conf. on Fuzzy Systems (FUZZ-IEEE'94), Vol. 3, Orlando, FL, USA, 1994, pp. 1708–1712
- L. Magdalena, F. Monasterio, A fuzzy logic controller with learning through the evolution of its knowledge base, Intl. J. Approx. Reasoning 16 (3–4) (1997) 335–358
- R. Gudwin, F. Gomide, W. Pedrycz, Context adaptation in fuzzy processing and genetic algorithms, Intl. J. Intell. Systems 13 (10/11) (1998) 929–948
- L. Magdalena, Adapting the gain of an FLC with genetic algorithms, Intl. J. Approximate Reasoning 17 (4) (1997) 327–349

# 3. Evolutionary Tuning of FRBSs

## OUTLINE

1. Introduction to GFSs
2. GFSs roadmap and milestones
- 3. Evolutionary tuning of FRBSs**
4. Classical GFS learning approaches
5. Some real-world applications
6. Advanced GFS approaches
7. Conclusions. What's next?

## 2. Tuning of membership functions

- A genetic tuning process that slightly adjusts the shapes of the membership functions of a preliminary DB definition
- Each chromosome encodes a whole DB definition by joining the partial coding of the different membership functions involved
- The coding scheme depends on:
  - The kind of membership function considered (triangular, trapezoidal, bell-shaped, ...) → different real-coded definition parameters
  - The kind of FRBS:
    - Grid-based: Each linguistic term in the fuzzy partition has a single fuzzy set definition associated
    - Non grid-based (free semantics, scatter partitions, fuzzy graphs): each variable in each rule has a different membership function definition

# 3. Evolutionary Tuning of FRBSs

## OUTLINE

1. Introduction to GFSs
2. GFSs roadmap and milestones
3. Evolutionary tuning of FRBSs
4. Classical GFS learning approaches
5. Some real-world applications
6. Advanced GFS approaches
7. Conclusions. What's next?

- **Example:** Tuning of the triangular membership functions of a grid-based SISO Mamdani-type FRBS, with three linguistic terms for each variable fuzzy partition
- Each chromosome encodes a different DB definition:
  - 2 (variables) · 3 (linguistic labels) = 6 membership functions
  - Each triangular membership function is encoded by 3 real values (the three definition points):
  - So, the chromosome length is  $6 \cdot 3 = 18$  real-coded genes (binary coding can be used but is not desirable)
- Either **definition intervals** have to be defined for each gene and/or appropriate genetic operators in order to obtain meaningful membership functions

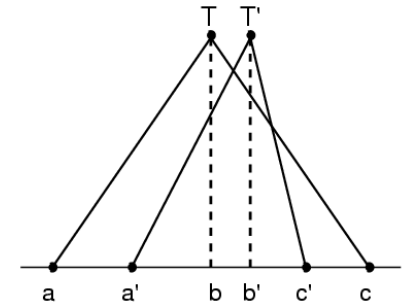

# 3. Evolutionary Tuning of FRBSs

## OUTLINE

1. Introduction to GFSs
2. GFSs roadmap and milestones
3. Evolutionary tuning of FRBSs
4. Classical GFS learning approaches
5. Some real-world applications
6. Advanced GFS approaches
7. Conclusions. What's next?

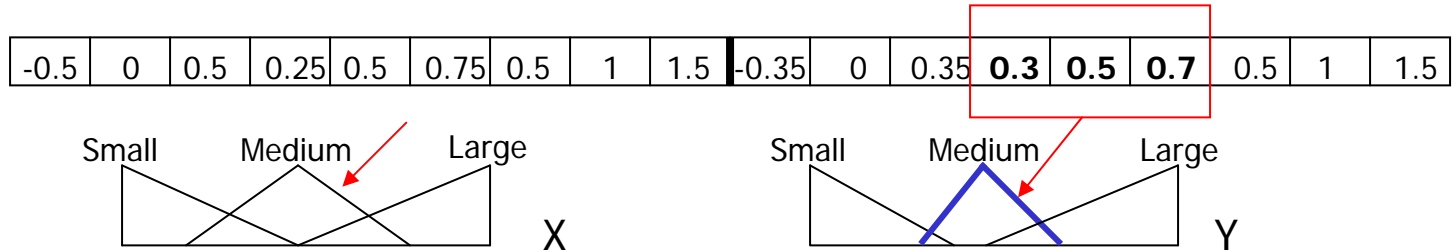
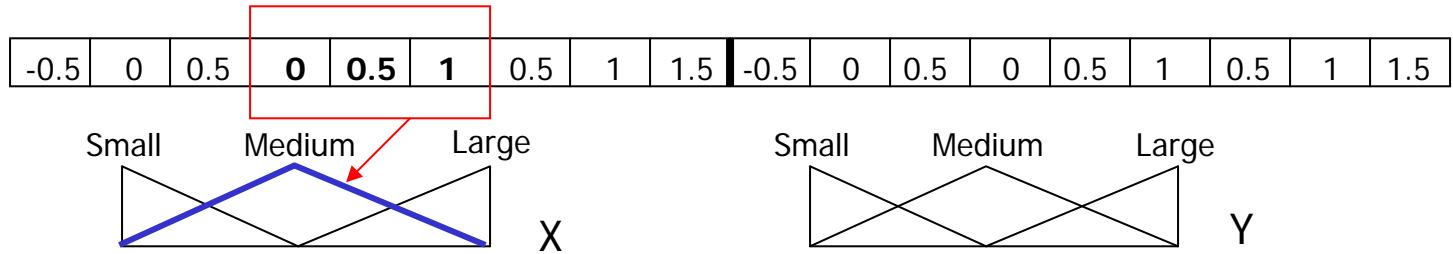

The RB remains unchanged!

R1: IF X1 is Small THEN Y is Large  
 R2: IF X1 is Medium THEN Y is Medium  
 ...

# 3. Evolutionary Tuning of FRBSs

## OUTLINE

1. Introduction to GFSs
2. GFSs roadmap and milestones
- 3. Evolutionary tuning of FRBSs**
4. Classical GFS learning approaches
5. Some real-world applications
6. Advanced GFS approaches
7. Conclusions. What's next?

## References:

- C. Karr, Genetic algorithms for fuzzy controllers, *AI Expert* 6 (2) (1991) 26–33
- C. Karr, E.J. Gentry, Fuzzy control of pH using genetic algorithms, *IEEE TFSs* 1 (1) (1993) 46–53
- J. Kinzel, F. Klawonn, R. Kruse, Modifications of genetic algorithms for designing and optimizing fuzzy controllers, *Proc. First IEEE Conf. on Evolutionary Computation (ICEC'94)*, Orlando, FL, USA, 1994, pp. 28–33
- D. Park, A. Kandel, G. Langholz, Genetic-based new fuzzy reasoning models with application to fuzzy control, *IEEE TSMC* 24 (1) (1994) 39–47
- F. Herrera, M. Lozano, J.L. Verdegay, Tuning fuzzy controllers by genetic algorithms, *IJAR* 12 (1995) 299–315
- P.P. Bonissone, P.S. Khedkar, Y. Chen, Genetic algorithms for automated tuning of fuzzy controllers: a transportation application, in *Proc. Fifth IEEE Int. Conf. on Fuzzy Systems (FUZZ-IEEE'96)*, New Orleans, USA, 1996, pp. 674–680
- O. Cordon, F. Herrera, A three-stage evolutionary process for learning descriptive and approximate fuzzy logic controller knowledge bases from examples, *IJAR* 17 (4) (1997) 369–407
- H.B. Gurocak, A genetic-algorithm-based method for tuning fuzzy logic controllers, *FSS* 108 (1) (1999) 39–47
- O. Cordon, F. Herrera, A two-stage evolutionary process for designing TSK fuzzy rule-based systems, *IEEE TSMC* 29 (6) (1999) 703–715

# 4. Classical GFS learning approaches

## OUTLINE

1. Introduction to GFSs
2. GFSs roadmap and milestones
3. Evolutionary tuning of FRBSs
- 4. Classical GFS learning approaches**
5. Some real-world applications
6. Advanced GFS approaches
7. Conclusions. What's next?

- Genetic derivation of the FRBS Rule Base
  - Michigan learning approach
  - Pittsburgh learning approach
  - Iterative Rule learning approach
  - Fuzzy rule coding
  - Examples
- Genetic selection of fuzzy rule sets
- Genetic derivation of the FRBS Knowledge Base
  - Single-stage GFSs
  - Multi-stage GFSs

# 4. Classical GFS learning approaches

## OUTLINE

1. Introduction to GFSs
2. GFSs roadmap and milestones
3. Evolutionary tuning of FRBSs
- 4. Classical GFS learning approaches**
5. Some real-world applications
6. Advanced GFS approaches
7. Conclusions. What's next?

## 1. Genetic derivation of the FRBS Rule Base

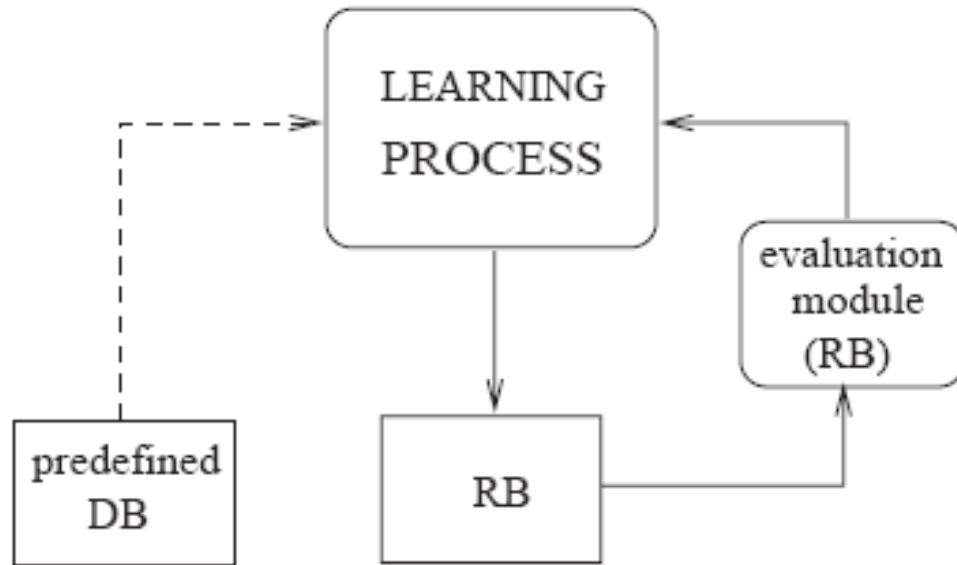

- The genetic learning of the RB assumes the existence of a predefined DB definition and looks for an optimal fuzzy rule set
- It only deals with grid-based Mamdani-type FRBSs



# 4. Classical GFS learning approaches

## OUTLINE

1. Introduction to GFSs
2. GFSs roadmap and milestones
3. Evolutionary tuning of FRBSs
- 4. Classical GFS learning approaches**
5. Some real-world applications
6. Advanced GFS approaches
7. Conclusions. What's next?

## Michigan Learning Approach:

- Each chromosome encodes a single fuzzy rule and the derived RB is composed of the whole population
- Reinforcement mechanisms (reward (credit apportion) and weight penalization) are considered to adapt the rules through a GA
- Low weight (bad performing) rules are substituted by new rules generated by the GA
- The key question is to induce collaboration in the derived RB as the evaluation procedure is at single rule level (**cooperation vs. competition problem (CCP)**)
- Mainly used in **on-line learning** (fuzzy control applications)

# 4. Classical GFS learning approaches

## OUTLINE

1. Introduction to GFSs
2. GFSs roadmap and milestones
3. Evolutionary tuning of FRBSs
4. **Classical GFS learning approaches**
5. Some real-world applications
6. Advanced GFS approaches
7. Conclusions. What's next?

## Michigan Learning Approach:

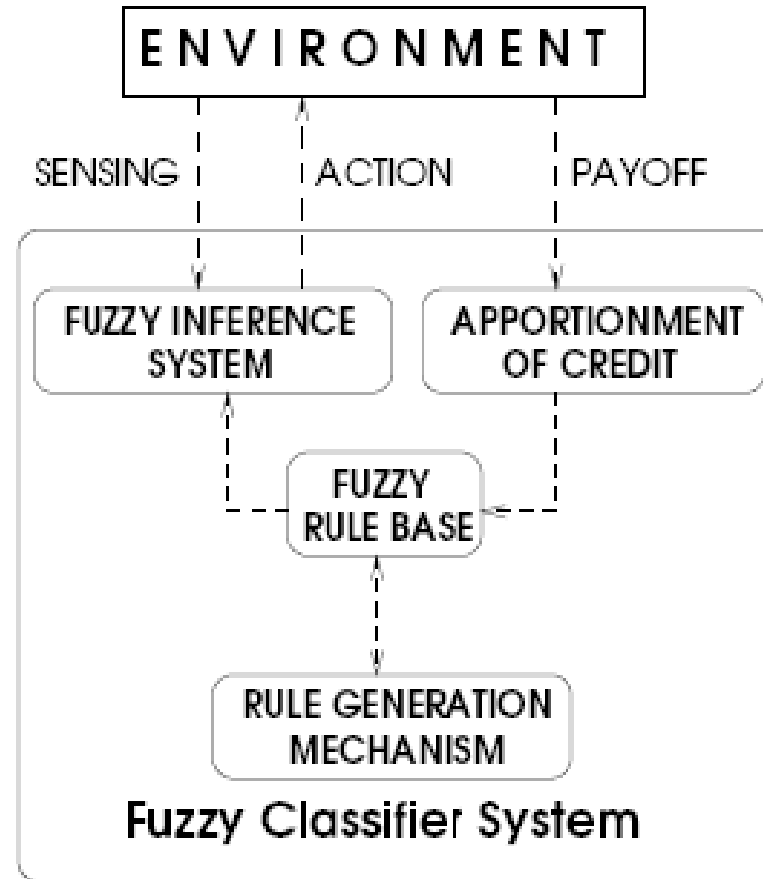

# 4. Classical GFS learning approaches

## OUTLINE

1. Introduction to GFSs
2. GFSs roadmap and milestones
3. Evolutionary tuning of FRBSs
- 4. Classical GFS learning approaches**
5. Some real-world applications
6. Advanced GFS approaches
7. Conclusions. What's next?

## Pittsburgh Learning Approach:

- Each chromosome encodes a whole fuzzy rule set and the derived RB is the best individual of the last population
- The fitness function evaluates the performance at the complete RB level, so the CCP is easy to solve
- However, the search space is huge, thus making difficult the problem solving and requiring sophisticated GFS designs
- Mainly used in **off-line learning** (fuzzy modeling and classification applications)

# 4. Classical GFS learning approaches

## OUTLINE

1. Introduction to GFSs
2. GFSs roadmap and milestones
3. Evolutionary tuning of FRBSs
- 4. Classical GFS learning approaches**
5. Some real-world applications
6. Advanced GFS approaches
7. Conclusions. What's next?

## Pittsburgh Learning Approach:

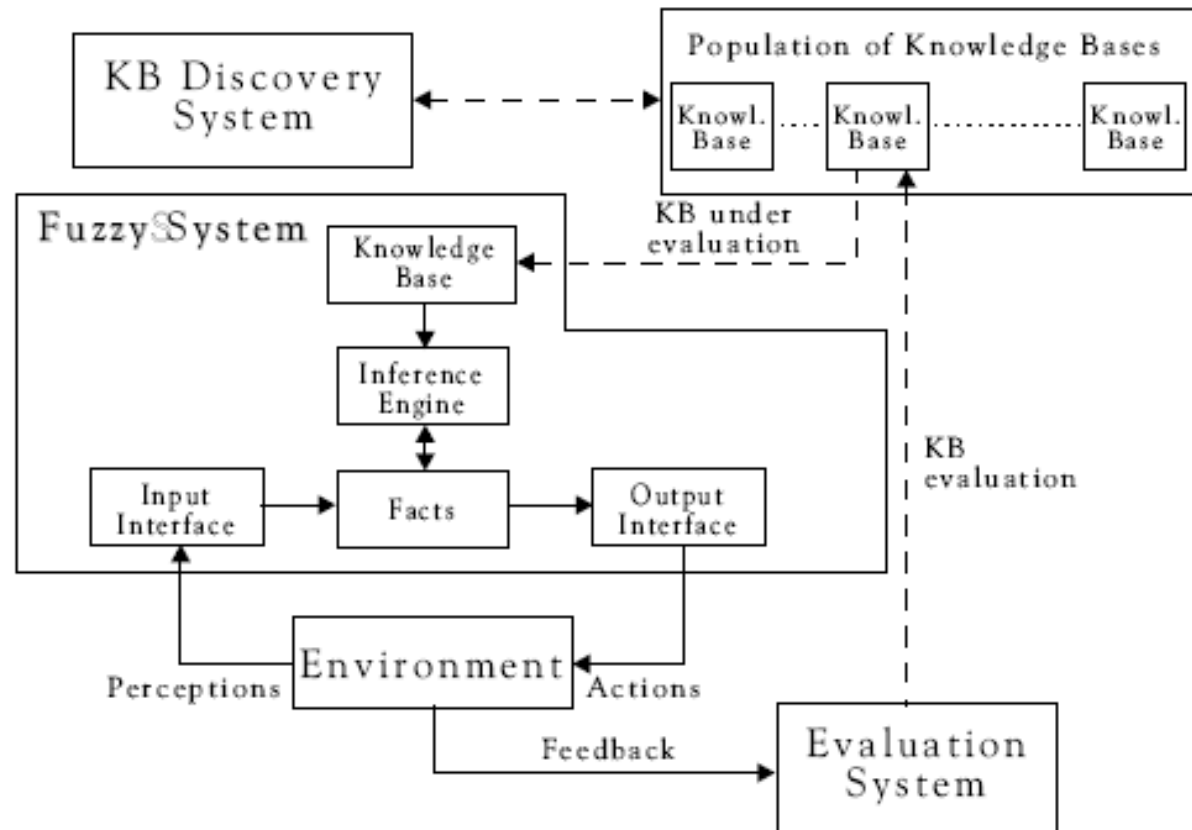

# 4. Classical GFS learning approaches

## OUTLINE

1. Introduction to GFSs
2. GFSs roadmap and milestones
3. Evolutionary tuning of FRBSs
- 4. Classical GFS learning approaches**
5. Some real-world applications
6. Advanced GFS approaches
7. Conclusions. What's next?

## Iterative Rule Learning Approach:

- Intermediate approach between the Michigan and Pittsburgh ones, based on partitioning the learning problem into several stages and leading to the design of multi-stage GFSs
- As in the Michigan approach, each chromosome encodes a single rule, but a new rule is learnt by an **iterative fuzzy rule generation stage** and added to the derived RB, in an iterative fashion, in independent and successive runs of the GA
- The evolution is guided by data covering criteria (rule competition). Some of them are considered to penalize the generation of rules covering examples already covered by the previously generated fuzzy rules (soft cooperation)

# 4. Classical GFS learning approaches

## OUTLINE

1. Introduction to GFSs
2. GFSs roadmap and milestones
3. Evolutionary tuning of FRBSs
- 4. Classical GFS learning approaches**
5. Some real-world applications
6. Advanced GFS approaches
7. Conclusions. What's next?

## Iterative Rule Learning Approach:

- A second **post-processing** stage is considered to refine the derived RB by selecting the most cooperative rule set and/or tuning the membership functions (cooperation induction)
- Hence, the CCP is solved taking the advantages of both the Michigan and Pittsburgh approaches (small search space and good chances to induce cooperation)
- Mainly used in **off-line learning** (fuzzy modeling and classification applications). **Not applicable for fuzzy control**

# 4. Classical GFS learning approaches

## OUTLINE

1. Introduction to GFSs
2. GFSs roadmap and milestones
3. Evolutionary tuning of FRBSs
- 4. Classical GFS learning approaches**
5. Some real-world applications
6. Advanced GFS approaches
7. Conclusions. What's next?

## Fuzzy rule coding:

- The RB can be represented as a relational matrix, a decision table, or a list of rules
- The two former ones are only useful when the FRBS has a reduced number of variables (huge chromosomes with more than two or three input variables)
- The list of rules is the most used representation and can be adapted to the three classical genetic learning approaches: Michigan, Pittsburgh and IRL

# 4. Classical GFS learning approaches

## OUTLINE

1. Introduction to GFSs
2. GFSs roadmap and milestones
3. Evolutionary tuning of FRBSs
4. **Classical GFS learning approaches**
5. Some real-world applications
6. Advanced GFS approaches
7. Conclusions. What's next?

## Thrift's GFS:

P. Thrift, *Fuzzy logic synthesis with genetic algorithms*, Proc. Fourth Intl. Conf. on Genetic Algorithms (ICGA'91), San Diego, USA, 1991, pp. 509–513

- Classical approach: Pittsburgh – the decision table is encoded in a rule consequent array
- The output variable linguistic terms are numbered from 1 to n and comprise the array values. The value 0 represents the rule absence, thus making the GA able to learn the optimal number of rules
- The ordered structure allows the GA to use simple genetic operators

	$X_1$	S	M	L
$X_2$				
S	R <sub>1</sub>	B	R <sub>2</sub>	—
M	R <sub>4</sub>	—	R <sub>5</sub>	M
L	R <sub>7</sub>	M	R <sub>8</sub>	—

1 2 3  
 $Y \rightarrow \{B, M, A\}$



1	0	2	0	2	0	2	0	3
---	---	---	---	---	---	---	---	---



# 4. Classical GFS learning approaches

## OUTLINE

1. Introduction to GFSs
2. GFSs roadmap and milestones
3. Evolutionary tuning of FRBSs
4. **Classical GFS learning approaches**
5. Some real-world applications
6. Advanced GFS approaches
7. Conclusions. What's next?

## Coding by a list of fuzzy rules:

- The problem of Thrift's decision table coding scheme is that it is difficult to reduce the RB size by only using the null value
- A good solution is to consider the **list of rules representation**, where each rule is individually coded and then the partial encodings are concatenated (Pittsburgh approach)

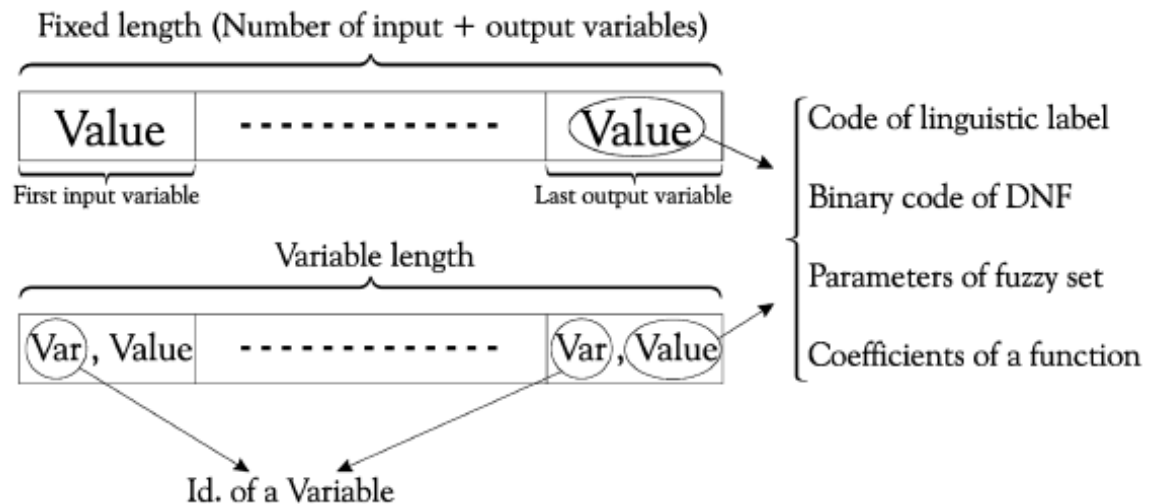



# 4. Classical GFS learning approaches

## OUTLINE

1. Introduction to GFSs

2. GFSs roadmap and milestones

3. Evolutionary tuning of FRBSs

4. **Classical GFS learning approaches**

5. Some real-world applications

6. Advanced GFS approaches

7. Conclusions. What's next?

- Often the number of rules in the list is variable (having in some cases an upper limit)
- Other chance is to **use variable-length chromosomes**: the population encode RBs with different number of rules
- The problem anyway is that **the genetic operators are more complicated since no rule ordering happens in the coding**
- Other chance is that the individual contains the code of a single rule (Michigan and IRL approaches)

# 4. Classical GFS learning approaches

## OUTLINE

1. Introduction to GFSs
2. GFSs roadmap and milestones
3. Evolutionary tuning of FRBSs
- 4. Classical GFS learning approaches**
5. Some real-world applications
6. Advanced GFS approaches
7. Conclusions. What's next?

- A common approach to code individual rules is the use of the disjunctive normal form (DNF) represented in the form of a fixed length binary string
- A **DNF fuzzy rule** allows an antecedent variable to take a **disjunction of linguistic terms from its domain** as a value:

IF Femur\_length is (medium or big-medium or big) and Head\_diameter is (medium) and Foetus\_sex is (male or female or unknown) THEN Foetus\_weight is normal

0	1	1	1	0	1	0	1	1	1	0	1	1
---	---	---	---	---	---	---	---	---	---	---	---	---

Femur\_length = {small, small-medium, medium, big-medium, big}

Head\_diameter = {small, medium, big}

Foetus\_sex = {male, female, unknown}

Foetus\_weight = {low, normal, high}

# 4. Classical GFS learning approaches

## OUTLINE

1. Introduction to GFSs
2. GFSs roadmap and milestones
3. Evolutionary tuning of FRBSs
4. Classical GFS learning approaches
5. Some real-world applications
6. Advanced GFS approaches
7. Conclusions. What's next?

- They carry some advantages such as the variable selection at rule level:

0	1	1	1	0	1	0	1	1	1	0	1	1
---	---	---	---	---	---	---	---	---	---	---	---	---

IF Femur\_length is (medium or big-medium or big) and Head\_diameter is (medium) and ~~Foetus\_sex is (male or female or unknown)~~ THEN Foetus\_weight is normal

or the label groupings making the rules more interpretable:

IF Femur\_length is (**not small**) and Head\_diameter is (medium) THEN Foetus\_weight is normal

They are thus usually considered for **classification problems**

- DNF rules have also been derived when working with variable length codes based on messy GAs



# 4. Classical GFS learning approaches

## OUTLINE

1. Introduction to GFSs
2. GFSs roadmap and milestones
3. Evolutionary tuning of FRBSs
4. **Classical GFS learning approaches**
5. Some real-world applications
6. Advanced GFS approaches
7. Conclusions. What's next?

## Hoffmann-Pfister's GFS:

F. Hoffmann, G. Pfister, Evolutionary design of a fuzzy knowledge base for a mobile robot, IJAR 17 (4) (1997) 447-469

- Variable-length Pittsburgh GA to learn DNF fuzzy rules with the list of rules representation
- **Messy GAs:**
  - position independent encoding
  - gene functionality defined by additional enumeration
  - variable length chromosome
  - Genetic crossover → cut and splice
  - Over- and under-specification

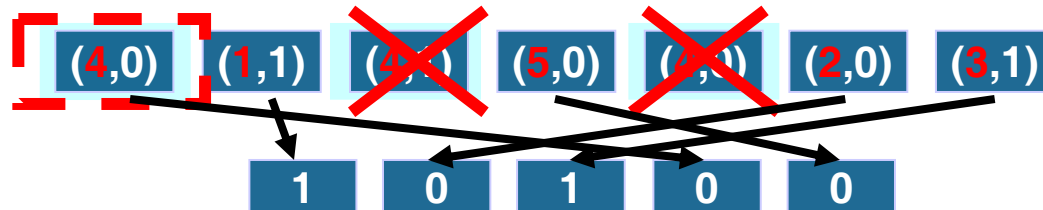



# 4. Classical GFS learning approaches

## OUTLINE

- 1. Introduction to GFSs
- 2. GFSs roadmap and milestones
- 3. Evolutionary tuning of FRBSs
- 4. **Classical GFS learning approaches**
- 5. Some real-world applications
- 6. Advanced GFS approaches
- 7. Conclusions. What's next?

## Fuzzy rule over-specification:

- Multiple output terms:  
Positional dominance

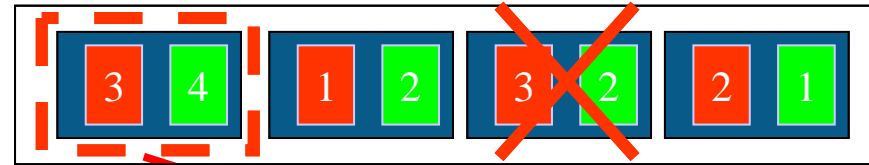

IF X1 is medium and X2 is small THEN Y is large

- Multiple input terms:  
Or-combination of terms  
for the same variable

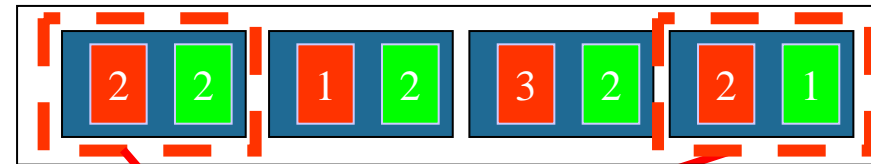

IF X1 is medium and X2 is (small or medium) THEN Y is large



# 4. Classical GFS learning approaches

## OUTLINE

- 1. Introduction to GFSs
- 2. GFSs roadmap and milestones
- 3. Evolutionary tuning of FRBSs
- 4. **Classical GFS learning approaches**
- 5. Some real-world applications
- 6. Advanced GFS approaches
- 7. Conclusions. What's next?

## Fuzzy rule under-specification:

- Missing output term:  
Randomly generate output clause

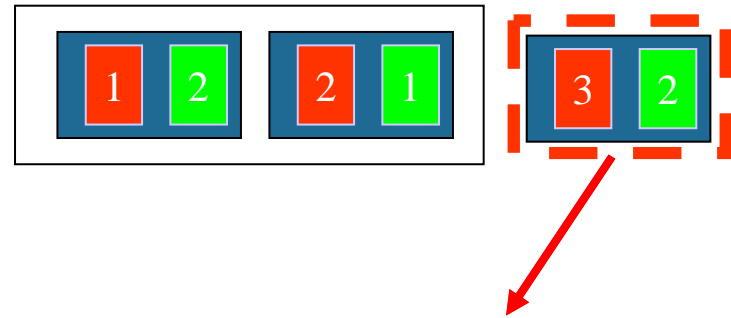

IF X1 is medium and X2 is small THEN Y is small

- Missing input variable:  
DNF rule variable selection

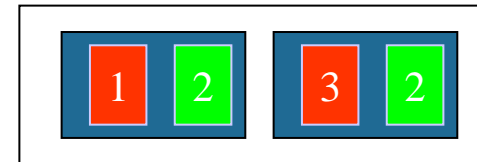

IF X1 is medium THEN Y is small



# 4. Classical GFS learning approaches

## OUTLINE

1. Introduction to GFSs
2. GFSs roadmap and milestones
3. Evolutionary tuning of FRBSs
- 4. Classical GFS learning approaches**
5. Some real-world applications
6. Advanced GFS approaches
7. Conclusions. What's next?

## References:

### Michigan Approach:

- M. Valenzuela-Rendón, The fuzzy classifier system: motivations and first results, Proc. First Intl. Conf. Parallel Problem Solving from Nature-PPSN I, Springer, Berlin, 1991, pp. 330–334 (scatter Mamdani fuzzy rules for control/modeling problems)
- A. Bonarini, Evolutionary learning of fuzzy rules: competition and cooperation, In: W. Pedrycz (Ed.): Fuzzy Modelling: Paradigms and Practice, Kluwer, 2006, 265-284 (Mamdani fuzzy rules for mobile robotics).
- M. Valenzuela-Rendón, Reinforcement learning in the fuzzy classifier system, Expert Systems with Applications 14 (1998) 237-247 (scatter Mamdani fuzzy rules for control/modeling problems)
- J.R. Velasco, Genetic-based on-line learning for fuzzy process control, IJIS 13 (10–11) (1998) 891–903 (scatter Mamdani fuzzy rules for control problems)
- H. Ishibuchi, T. Nakashima, T. Murata, Performance evaluation of fuzzy classifier systems for multidimensional pattern classification problems, IEEE TSMC 29 (1999) 601–618 (Mamdani fuzzy rules for classification problems)

# 4. Classical GFS learning approaches

## OUTLINE

1. Introduction to GFSs
2. GFSs roadmap and milestones
3. Evolutionary tuning of FRBSs
- 4. Classical GFS learning approaches**
5. Some real-world applications
6. Advanced GFS approaches
7. Conclusions. What's next?

## References:

### Pittsburgh Approach:

- P. Thrift, Fuzzy logic synthesis with genetic algorithms, Proc. Fourth Intl. Conf. on Genetic Algorithms (ICGA'91), San Diego, USA, 1991, pp. 509–513 (decision table)
- D.T. Pham, D. Karaboga, Optimum design of fuzzy logic controllers using genetic algorithms, J. System Eng. 1 (1991) 114–118 (relational matrix)
- F. Hoffmann, G. Pfister, Evolutionary design of a fuzzy knowledge base for a mobile robot, IJAR 17 (4) (1997) 447–469 (list of DNF fuzzy rules)
- L. Magdalena, Crossing unordered sets of rules in evolutionary fuzzy controllers, IJIS 13 (10-11) (1998) 993-1010 (list of Mamdani fuzzy rules)

# 4. Classical GFS learning approaches

## OUTLINE

1. Introduction to GFSs
2. GFSs roadmap and milestones
3. Evolutionary tuning of FRBSs
- 4. Classical GFS learning approaches**
5. Some real-world applications
6. Advanced GFS approaches
7. Conclusions. What's next?

## References:

### IRL Approach:

- A. González, R. Pérez, Completeness and consistency conditions for learning fuzzy rules, *FSS 96* (1) (1996) 37-51 (DNF fuzzy rules for classification problems)
- O. Cordón, F. Herrera, A three-stage evolutionary process for learning descriptive and approximate fuzzy logic controller knowledge bases from examples, *IJAR 17* (4) (1997) 369–407 (grid-based and scatter Mamdani fuzzy rules for control/modeling problems)
- O. Cordón, M.J. del Jesus, F. Herrera, Genetic learning of fuzzy rule-based classification systems cooperating with fuzzy reasoning methods, *IJIS 13* (10–11) (1998) 1025–1053 (Mamdani fuzzy rules for classification problems)
- A. González, R. Pérez, A fuzzy theory refinement algorithm, *IJAR 19* (1998) 193-200 (DNF fuzzy rules for classification and control problems)
- A. González, R. Pérez, SLAVE: a genetic learning system based on an iterative approach, *IEEE TFS 7* (2) (1999) 176–191 (DNF fuzzy rules for classification problems)

# 4. Classical GFS learning approaches

## OUTLINE

1. Introduction to GFSs
2. GFSs roadmap and milestones
3. Evolutionary tuning of FRBSs
- 4. Classical GFS learning approaches**
5. Some real-world applications
6. Advanced GFS approaches
7. Conclusions. What's next?

## 2. Genetic selection of fuzzy rule sets

### MOTIVATION:

- In high-dimensional problems, the number of rules in the RB grows exponentially as more inputs are added
- Hence, a fuzzy rule generation method is likely to derive fuzzy rule sets including:
  - **redundant rules**: whose actions are covered by other rules,
  - **wrong rules**: badly defined and perturbing the system performance, and
  - **conflicting rules**: that worsen the system performance when co-existing with other rules in the RB
- **Rule reduction methods** are used as postprocessing techniques to solve the latter problems

# 4. Classical GFS learning approaches

## OUTLINE

1. Introduction to GFSs
2. GFSs roadmap and milestones
3. Evolutionary tuning of FRBSs
- 4. Classical GFS learning approaches**
5. Some real-world applications
6. Advanced GFS approaches
7. Conclusions. What's next?

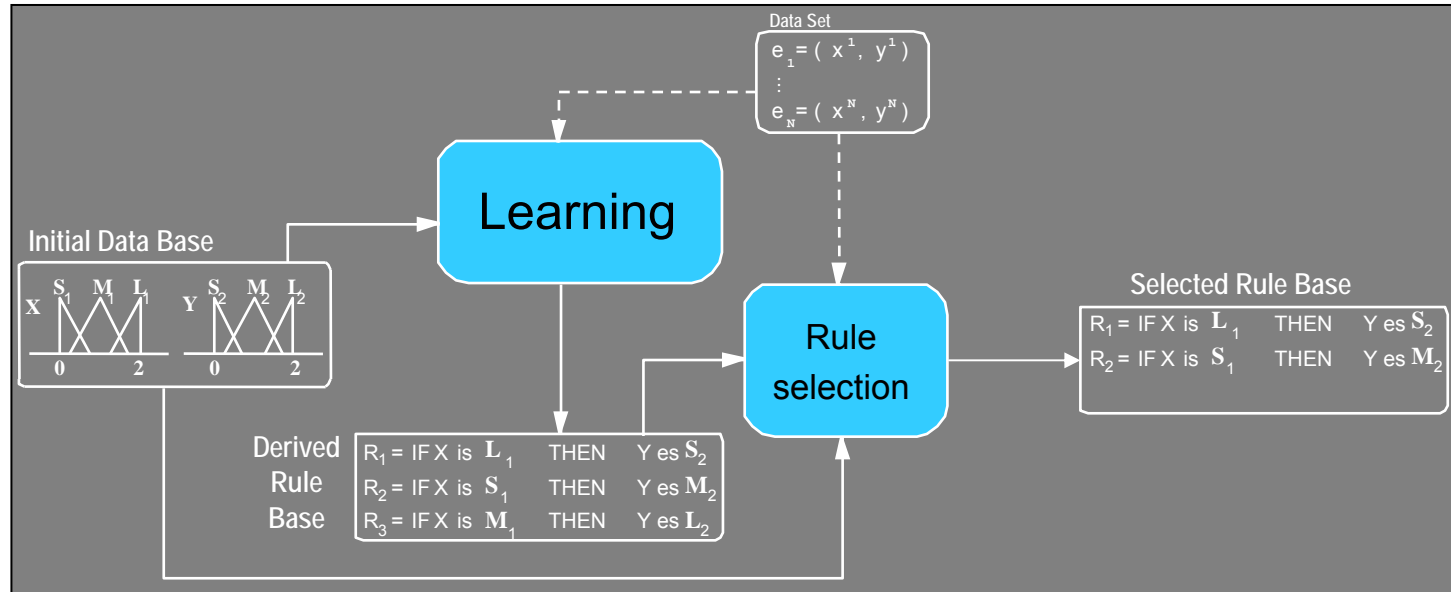

There are two different rule reduction approaches:

- Combination of the membership functions of two or more rules, reducing them to a single ones (scatter partition FRBSs)
- **Selection of fuzzy rules**, getting rule subsets with a good cooperation from the initial RB (descriptive and scatter FRBSs)

# 4. Classical GFS learning approaches

## OUTLINE

1. Introduction to GFSs
2. GFSs roadmap and milestones
3. Evolutionary tuning of FRBSs
- 4. Classical GFS learning approaches**
5. Some real-world applications
6. Advanced GFS approaches
7. Conclusions. What's next?

- **Example:** Binary GA for rule selection
- The coding scheme considers binary strings of fixed length  $m$  (number of rules of the initial RB):

Allele '0'  $\Rightarrow$  the corresponding rule IS NOT selected

Allele '1'  $\Rightarrow$  the corresponding rule IS NOT selected

- Initial population generation:

$$C_1^1[k] = 1, \forall k \in \{1, K, m\}$$
$$C_1^p[k] = 0, \forall k \in \{1, K, m\}, p \neq 1$$

- Genetic operators:
  - Two-point crossover
  - Bit flipping mutation

# 4. Classical GFS learning approaches

## OUTLINE

1. Introduction to GFSs
2. GFSs roadmap and milestones
3. Evolutionary tuning of FRBSs
- 4. Classical GFS learning approaches**
5. Some real-world applications
6. Advanced GFS approaches
7. Conclusions. What's next?

## References:

- H. Ishibuchi, K. Nozaki, N. Yamamoto, H. Tanaka, Selecting fuzzy if-then rules for classification problems using genetic algorithms, *IEEE Trans. Fuzzy Systems* 3 (3) (1995) 260–270
- O. Cordón, F. Herrera, A three-stage evolutionary process for learning descriptive and approximate fuzzy logic controller knowledge bases from examples, *IJAR* 17 (4) (1997) 369–407
- O. Cordón, M.J. del Jesus, F. Herrera, Genetic learning of fuzzy rule-based classification systems cooperating with fuzzy reasoning methods, *IJIS* 13 (10–11) (1998) 1025–1053
- C.H. Wang, T.P. Hong, S.S. Tseng, Integrating fuzzy knowledge by genetic algorithms, *IEEE TEC* 2 (4) (1998) 138–149

# 4. Classical GFS learning approaches

## OUTLINE

1. Introduction to GFSs
2. GFSs roadmap and milestones
3. Evolutionary tuning of FRBSs
- 4. Classical GFS learning approaches**
5. Some real-world applications
6. Advanced GFS approaches
7. Conclusions. What's next?

## 3. Genetic derivation of the FRBS Knowledge Base

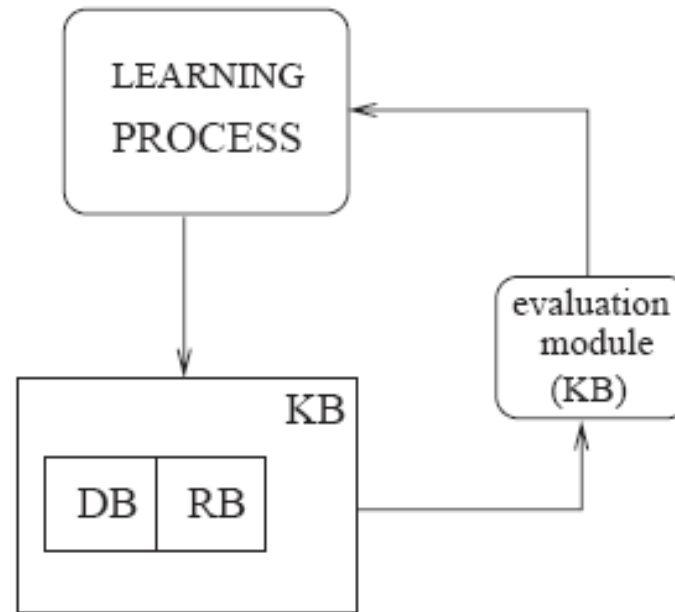

- The genetic learning process of the KB must **jointly** determine:
  - Membership function definitions
  - Fuzzy rules
- and sometimes also:
  - Scaling factors/functions
  - Linguistic terms (fuzzy partition granularity)



# 4. Classical GFS learning approaches

## OUTLINE

1. Introduction to GFSs
2. GFSs roadmap and milestones
3. Evolutionary tuning of FRBSs
4. Classical GFS learning approaches
5. Some real-world applications
6. Advanced GFS approaches
7. Conclusions. What's next?

- Information items to be encoded into a chromosome:

- Scaling factors
- Membership functions
- Fuzzy rules

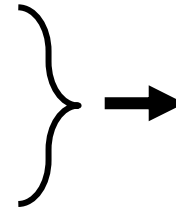

Fixed or variable-length coding scheme

- Each information level is an independent chromosome part (**multi-chromosomes**)
- Different ways to adapt this two-level structure (DB and RB information) through crossover:
  - As a single one, by merging the substructures
  - As two unrelated substructures, applying a parallel process
  - As two related substructures, applying a sequential process where the result of crossing over one of them affects the crossover of the other



# 4. Classical GFS learning approaches

## OUTLINE

1. Introduction to GFSs
2. GFSs roadmap and milestones
3. Evolutionary tuning of FRBSs
- 4. Classical GFS learning approaches**
5. Some real-world applications
6. Advanced GFS approaches
7. Conclusions. What's next?

- **Example:** SISO fuzzy control problem with 3 labels per variable:

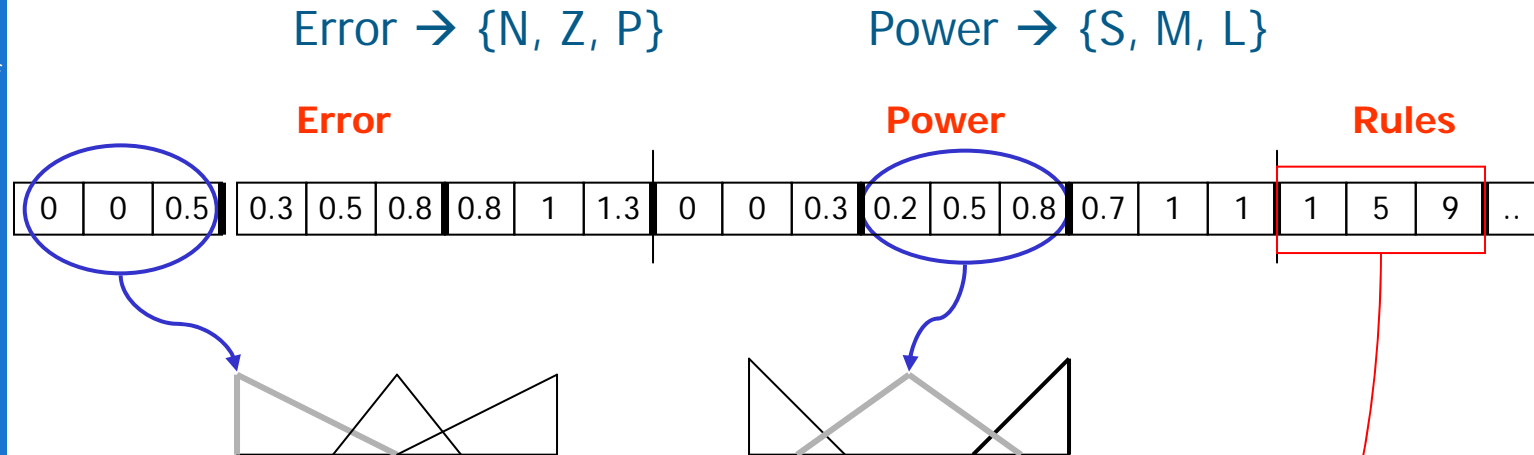

R1: IF Error is Negative THEN Power is Large

R2:    ...

# 4. Classical GFS learning approaches

## OUTLINE

1. Introduction to GFSs
2. GFSs roadmap and milestones
3. Evolutionary tuning of FRBSs
- 4. Classical GFS learning approaches**
5. Some real-world applications
6. Advanced GFS approaches
7. Conclusions. What's next?

- The **search space** is thus **very large and** complex, causing problems to the Pittsburgh approach:
  - Variable-length chromosomes, or
  - one rule per chromosome (Michigan or IRL) with scatter partitions, or
  - multi-stage GFSs
- The **problem is simpler for the case of scatter partition Mamdani-type FRBSs**, since each rule has its own semantics and so the chromosome has a single information level (list of rules representation)

# 4. Classical GFS learning approaches

## OUTLINE

1. Introduction to GFSs
2. GFSs roadmap and milestones
3. Evolutionary tuning of FRBSs
4. Classical GFS learning approaches
5. Some real-world applications
6. Advanced GFS approaches
7. Conclusions. What's next?

- Some approaches partition the learning problem and try to improve the DB definition, once the RB has been derived (**multi-stage GFSs**):
  1. Initial genetic RB learning (*predefined DB*)
  2. Genetic DB learning (tuning) (*derived RB from the previous step*)

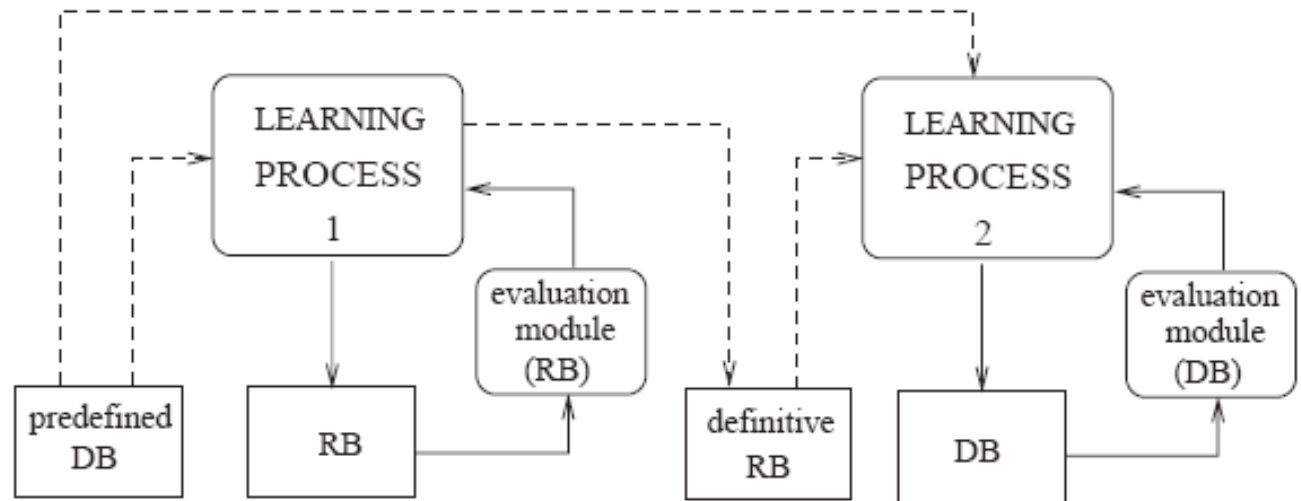

- This is the usual case for GFSs based on the IRL approach

# 4. Classical GFS learning approaches

## OUTLINE

1. Introduction to GFSs
2. GFSs roadmap and milestones
3. Evolutionary tuning of FRBSs
- 4. Classical GFS learning approaches**
5. Some real-world applications
6. Advanced GFS approaches
7. Conclusions. What's next?

## References:

### Michigan Approach:

- M. Valenzuela-Rendón, The fuzzy classifier system: motivations and first results, Proc. First Intl. Conf. on Parallel Problem Solving from Nature-PPSN I, Springer, Berlin, 1991, pp. 330–334 (scatter Mamdani fuzzy rules for control/modeling problems)
- M. Valenzuela-Rendón, Reinforcement learning in the fuzzy classifier system, Expert Systems with Applications 14 (1998) 237-247 (scatter Mamdani fuzzy rules for control/modeling problems)
- J.R. Velasco, Genetic-based on-line learning for fuzzy process control, IJIS 13 (10–11) (1998) 891–903 (scatter Mamdani fuzzy rules for control problems)

# 4. Classical GFS learning approaches

## OUTLINE

1. Introduction to GFSs
2. GFSs roadmap and milestones
3. Evolutionary tuning of FRBSs
- 4. Classical GFS learning approaches**
5. Some real-world applications
6. Advanced GFS approaches
7. Conclusions. What's next?

## References:

### Pittsburgh Approach:

- M.A. Lee, H. Takagi, Integrating design stages of fuzzy systems using genetic algorithms, Proc. 2nd IEEE Intl. Conf. on Fuzzy Systems (FUZZ-IEEE'93), San Francisco, USA, 1993, pp. 613–617 (Mamdani fuzzy rules for control problems)
- D. Park, A. Kandel, G. Langholz, Genetic-based new fuzzy reasoning models with application to fuzzy control, IEEE TSMC 24 (1) (1994) 39–47 (relational matrix for control problems)
- B. Carse, T.C. Fogarty, A. Munro, Evolving fuzzy rule based controllers using genetic algorithms, FSS 80 (1996) 273–294 (scatter Mamdani fuzzy rules for control problems)
- L. Magdalena, F. Monasterio, A fuzzy logic controller with learning through the evolution of its knowledge base, IJAR 16 (3–4) (1997) 335–358 (DNF Mamdani fuzzy rules for control problems)
- H. Heider, T. Drabe, A cascade genetic algorithm for improving fuzzy-system design, IJAR 17 (4) (1997) 351–368 (Mamdani fuzzy rules for control/modeling problems)

# 4. Classical GFS learning approaches

## OUTLINE

1. Introduction to GFSs
2. GFSs roadmap and milestones
3. Evolutionary tuning of FRBSs
- 4. Classical GFS learning approaches**
5. Some real-world applications
6. Advanced GFS approaches
7. Conclusions. What's next?

## References:

### IRL Approach:

- O. Cordón, F. Herrera, A three-stage evolutionary process for learning descriptive and approximate fuzzy logic controller knowledge bases from examples, IJAR 17 (4) (1997) 369–407 (grid-based and scatter Mamdani fuzzy rules for control/modeling problems)
- O. Cordón, M.J. del Jesus, F. Herrera, Genetic learning of fuzzy rule-based classification systems cooperating with fuzzy reasoning methods, IJIS 13 (10–11) (1998) 1025–1053 (Mamdani fuzzy rules for classification problems)
- O. Cordón, F. Herrera, A two-stage evolutionary process for designing TSK fuzzy rule-based systems, IEEE TSMC 29 (6) (1999) 703–715 (TSK fuzzy rules for classification problems)
- O. Cordón, M.J. del Jesus, F. Herrera, M. Lozano, MOGUL: a methodology to obtain genetic fuzzy rule-based systems under the iterative rule learning approach, IJIS 14 (11) (1999) 1123–1153 (generic methodology for different kinds of fuzzy rules and problems)

# 5. Some real-world applications

## OUTLINE

1. Introduction to GFSs
2. GFSs roadmap and milestones
3. Evolutionary tuning of FRBSs
4. Classical GFS learning approaches
5. **Some real-world applications**
6. Advanced GFS approaches
7. Conclusions. What's next?

## Control:

- Inverted pendulum, Cart-pole
- Biped robot walking (Magdalena, 1994)
- Fossil power plant operation supervision (Magdalena-Velasco, 1995)
- Control strategies for trains (Bonissone, 1996; Hwang, 1998)
- Industrial processes (Huang, 1998)
- Mobile Robotics: basic behaviors (obstacle avoidance, wall following, ...); behavior coordination, visual systems (Bonarini, 1996,1997; Hoffmann, 1996; Muñoz-Salinas, 2006; ...)
- Helicopter control (Hoffmann, 2001)
- Photovoltaic Systems (Magdalena, 2001)
- HVAC systems (Alcalá, 2003, 2005)
- Hybrid resonant-driven linear piezoelectric ceramic motor (Wai, 2007)
- F16 aircraft flight controller (Stewart, 2007)



# 5. Some real-world applications

## OUTLINE

1. Introduction to GFSs
2. GFSs roadmap and milestones
3. Evolutionary tuning of FRBSs
4. Classical GFS learning approaches
- 5. Some real-world applications**
6. Advanced GFS approaches
7. Conclusions. What's next?

## Modeling/Forecasting:

- Food quality evaluation by sensorial tests (Ishibuchi, 1994; Guilleaume, 2002)
- Dental development age prediction (Lee, 1996)
- Electrical distribution problems (Sanchez, 1997; Cerdón, 1999)
- Intelligent consumer products (dish washer, microwave oven, ...)  
(Shim, 1999)
- Color prediction for paint production (Mizutani, 2000)
- Wind forecasting for power generation in wind farms (Damousis, 2001)
- Decision systems for insurance risk assessment (Bonissone, 2002)
- Ecological problems (Van Broekhoven, 2007)
- Environmental modeling (Nebot, 2007)

# 5. Some real-world applications

## OUTLINE

1. Introduction to GFSs
2. GFSs roadmap and milestones
3. Evolutionary tuning of FRBSs
4. Classical GFS learning approaches
- 5. Some real-world applications**
6. Advanced GFS approaches
7. Conclusions. What's next?

## Classification/Diagnosis:

- Myocardial infarction diagnosis (González, 1995)
- Classification of defects in sheets of glass (Sánchez, 1998)
- Breast cancer diagnosis (Peña-Reyes, 1999)
- Cardio-vascular diseases risk prediction (Cordón, 2002)
- Classification of amino acid sequences (Bandyopadhyay, 2005)
- Matrix crack detection in thin-wafled composite beam (Pawar, 2005)
- Intrusion detection (Abadeh, 2007)
- Microcalcification classification in digital mammograms (Jiang, 2007)
- Structural health monitoring of helicopter rotor blades (Pawar, 2007)

## Optimization:

- Railway networks timetable (Voget, 1998)
- Supply strategies for the electrical market (Sánchez, 2003)
- Scheduling (Gomide, 2000; Franke, 2007)

# 5. Some real-world applications

## OUTLINE

1. Introduction to GFSs
2. GFSs roadmap and milestones
3. Evolutionary tuning of FRBSs
4. Classical GFS learning approaches
5. **Some real-world applications**
6. Advanced GFS approaches
7. Conclusions. What's next?

## Biped robot walking control

L. Magdalena, F. Monasterio, A fuzzy logic controller with learning through the evolution of its knowledge base, IJAR 16 (3-4) (1997) 335-358

- Anthropomorphic structure
- Searching for the sequence of movements allowing continuous and regular walking
- Magdalena's Pittsburgh GFS to learn different gait controls

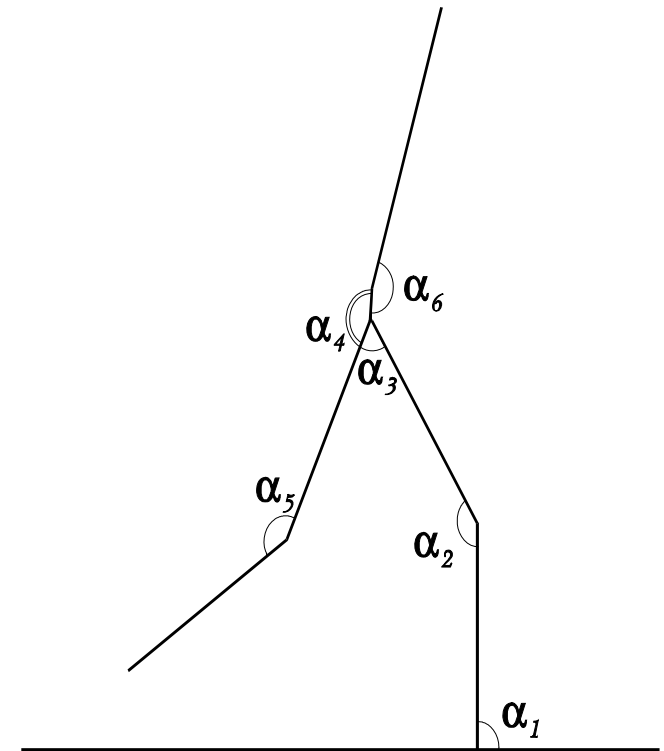

# 5. Some real-world applications

## OUTLINE

1. Introduction to GFSs
2. GFSs roadmap and milestones
3. Evolutionary tuning of FRBSs
4. Classical GFS learning approaches
- 5. Some real-world applications**
6. Advanced GFS approaches
7. Conclusions. What's next?

## Biped robot walking control

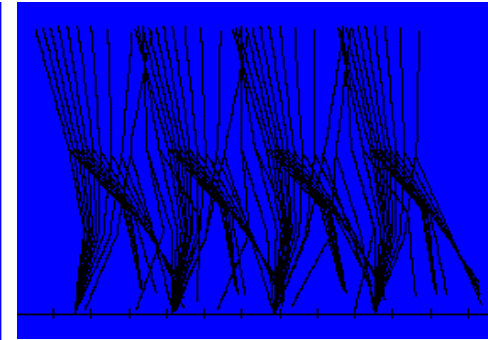
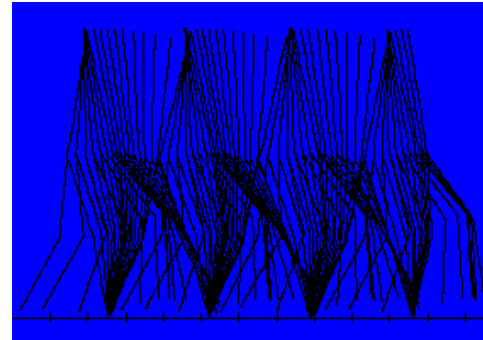
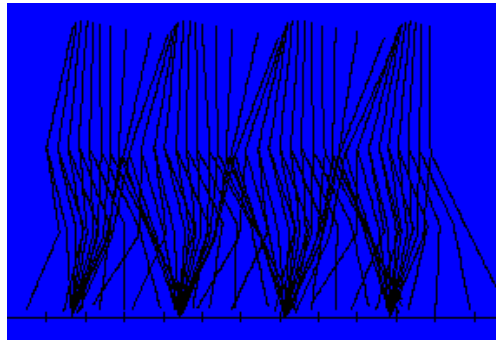
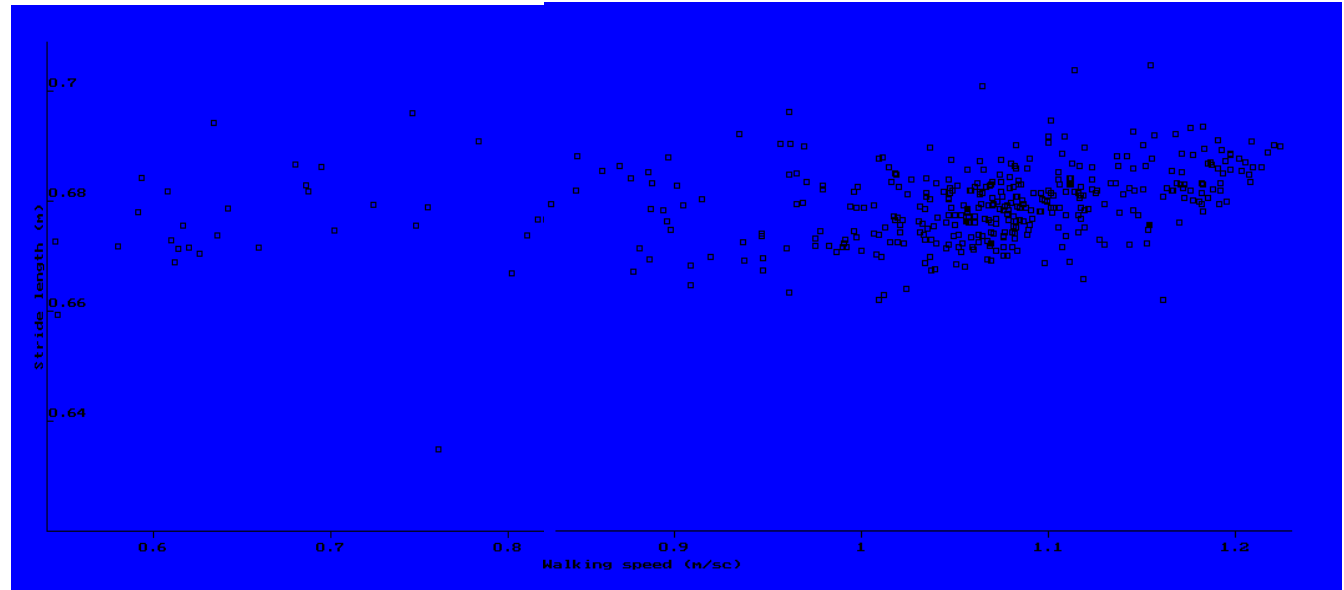

# 5. Some real-world applications

## OUTLINE

1. Introduction to GFSs
2. GFSs roadmap and milestones
3. Evolutionary tuning of FRBSs
4. Classical GFS learning approaches
5. **Some real-world applications**
6. Advanced GFS approaches
7. Conclusions. What's next?

## Mobile robotics: obstacle avoidance

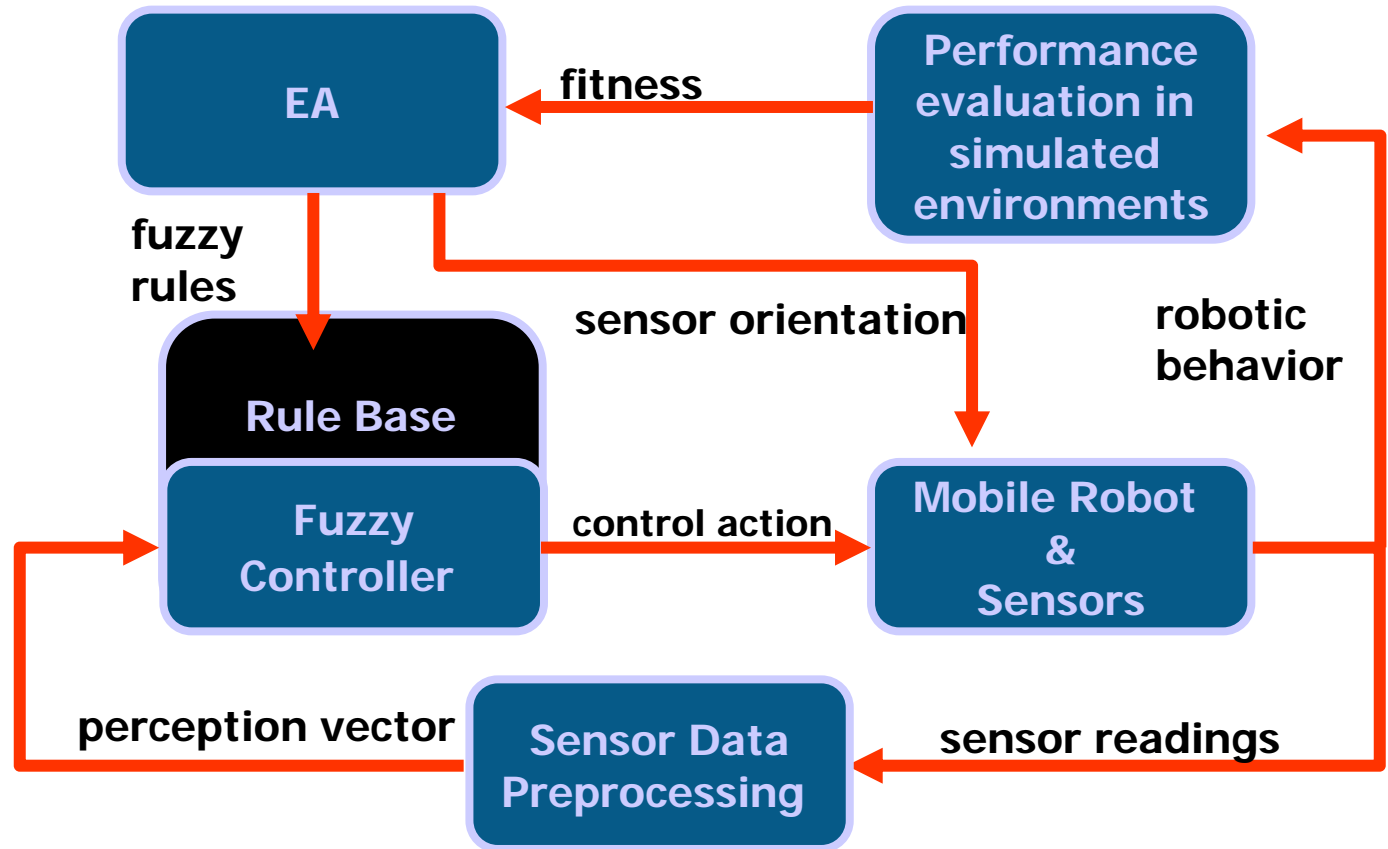

# 5. Some real-world applications

## OUTLINE

1. Introduction to GFSs
2. GFSs roadmap and milestones
3. Evolutionary tuning of FRBSs
4. Classical GFS learning approaches
5. **Some real-world applications**
6. Advanced GFS approaches
7. Conclusions. What's next?

## Mobile robotics: obstacle avoidance

### Perception

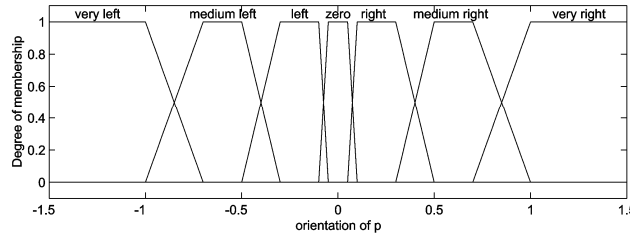
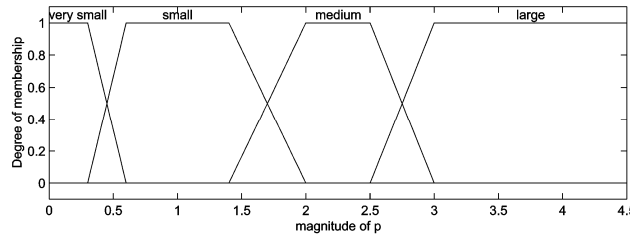

### Action

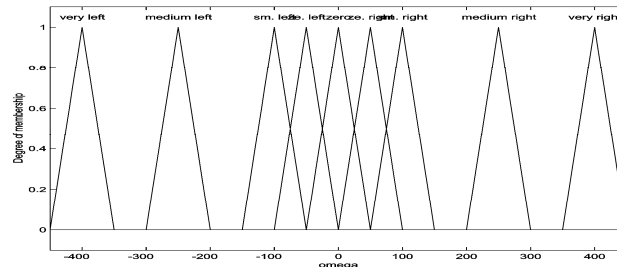

### Initial RB

$\omega$	$\angle \vec{P}$						
	VL	ML	SL	ZE	SR	MR	VR
VS	ZE	ZE	ZE	NZ	ZE	ZE	ZE
$ \vec{P} $ SM	ZE	NZ	NZ	NZ	PZ	PZ	ZE
ME	ZE	NZ	NS	NM	PS	PZ	ZE
LG	NZ	NS	NM	NB	PM	PS	PZ

### Evolved RB

$\omega$	$\angle \vec{P}$						
	VL	ML	SL	ZE	SR	MR	VR
VS	ZE	PS	NM	NB	NS	NB	PM
$ \vec{P} $ SM	NZ	NZ	NB	PZ	NB	NM	NZ
ME	NZ	PS	NS	PZ	NM	ZE	NB
LG	PS	PZ	NZ	NZ	ZE	NB	PZ

### Thrift's GFS

# 5. Some real-world applications

## OUTLINE

1. Introduction to GFSs
2. GFSs roadmap and milestones
3. Evolutionary tuning of FRBSs
4. Classical GFS learning approaches
5. **Some real-world applications**
6. Advanced GFS approaches
7. Conclusions. What's next?

## Obtained results in the real environment

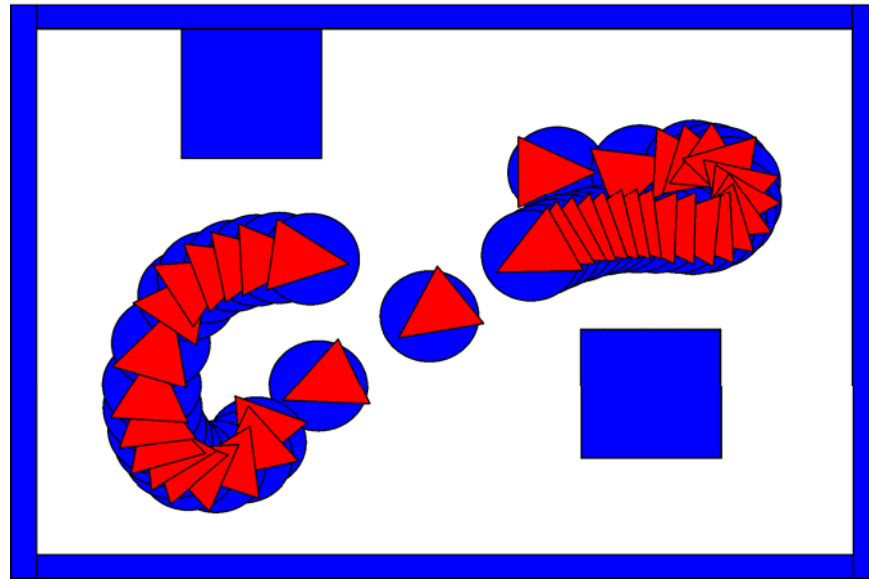

# 5. Some real-world applications

## OUTLINE

1. Introduction to GFSs
2. GFSs roadmap and milestones
3. Evolutionary tuning of FRBSs
4. Classical GFS learning approaches
5. **Some real-world applications**
6. Advanced GFS approaches
7. Conclusions. What's next?

## Maintenance cost estimation for low and medium voltage lines in Spain:

O. Cordón, F. Herrera, L. Sánchez, Solving electrical distribution problems using hybrid evolutionary data analysis techniques, *Appl. Intell.* 10 (1999) 5-24

- **Spain's electrical market (before 1998):** Electrical companies shared a business, Red Eléctrica Española, receiving all the client fees and distributing them among the partners
- The payment distribution was done according to some complex criteria that the government decided to change
- One of them was related to the maintenance costs of the power line belonging to each company
- The different producers were in trouble to compute them since:
  - As **low voltage lines** are installed in small villages, there were no actual measurement of their length
  - The government wanted the maintenance costs of the optimal **medium voltage lines** installation and not of the real one, built incrementally



# 5. Some real-world applications

## OUTLINE

1. Introduction to GFSs
2. GFSs roadmap and milestones
3. Evolutionary tuning of FRBSs
4. Classical GFS learning approaches
5. **Some real-world applications**
6. Advanced GFS approaches
7. Conclusions. What's next?

## Low voltage line maintenance cost estimation:

- **Goal:** estimation of the low voltage electrical line length installed in 1000 rural towns in Asturias
- **Two input variables:** number of inhabitants and radius of village
- **Output variable:** length of low voltage line
- Data set composed of **495** rural nuclei, **manually measured and affected by noise**
- **396** (80%) examples for **training** and **99** (20%) examples for **test** randomly selected
- **Seven** linguistic terms for each linguistic variable

# 5. Some real-world applications

## OUTLINE

1. Introduction to GFSs
2. GFSs roadmap and milestones
3. Evolutionary tuning of FRBSs
4. Classical GFS learning approaches
5. **Some real-world applications**
6. Advanced GFS approaches
7. Conclusions. What's next?

## Low voltage line maintenance cost estimation:

- **Classical solution:** numerical regression on different models of the line installation in the villages

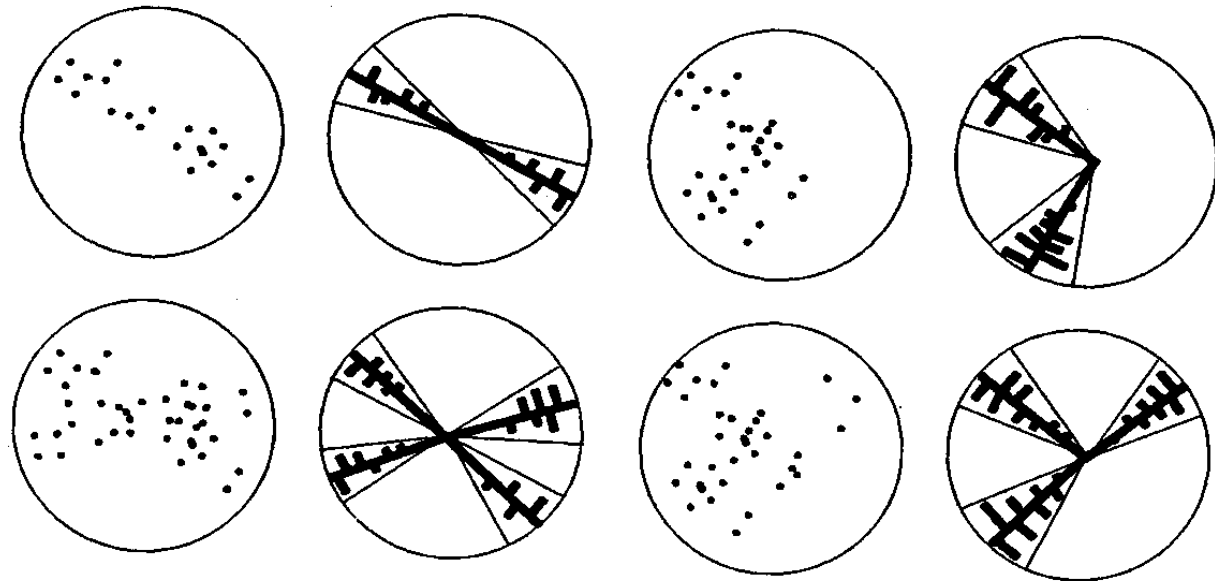

# 5. Some real-world applications

## OUTLINE

1. Introduction to GFSs
2. GFSs roadmap and milestones
3. Evolutionary tuning of FRBSs
4. Classical GFS learning approaches
5. **Some real-world applications**
6. Advanced GFS approaches
7. Conclusions. What's next?

## Performance comparison of different fuzzy modeling methods

Method	#R	MSE <sub>tra</sub>	MSE <sub>test</sub>
Wang-Mendel	24	222,623	240,566
Cordón-Herrera	32	267,923	249,523
Ishibuchi (simp. TSK)	32	173,230	190,808
<b>Thrift</b>	47	185,204	<b>168,060</b>
Shan-Fu	45	1,281,547	1,067,993
ANFIS	49	256,605	268,451
FCM	49	<b>163,615</b>	198,617
Chiu+FCM	37	200,999	222,362
3rd order polynomial regression	49 nodes, 2 pars.	235,934	202,991
NN 2-25-1	102 par.	169,399	<b>167,092</b>

# 5. Some real-world applications

## OUTLINE

1. Introduction to GFSs
2. GFSs roadmap and milestones
3. Evolutionary tuning of FRBSs
4. Classical GFS learning approaches
5. **Some real-world applications**
6. Advanced GFS approaches
7. Conclusions. What's next?

## Medium voltage line maintenance cost estimation:

- **Goal:** estimation of the maintenance cost of the **optimal** medium voltage electrical line installed in the Asturias' towns
- **Four input variables:** street length, total area, total area occupied by buildings, and supplied energy
- **Output variable:** medium voltage line maintenance costs
- Data set composed of **1059 simulated** cities
- **847** (80%) examples for **training** and **212** (20%) examples for test randomly selected
- **Five** linguistic terms for each linguistic variable

# 5. Some real-world applications

## OUTLINE

1. Introduction to GFSs
2. GFSs roadmap and milestones
3. Evolutionary tuning of FRBSs
4. Classical GFS learning approaches
5. **Some real-world applications**
6. Advanced GFS approaches
7. Conclusions. What's next?

## Performance comparison of different fuzzy modeling methods

Method	#R	MSE <sub>tra</sub>	MSE <sub>test</sub>
Wang-Mendel (3 labels)	28	197,313	174,400
Wang-Mendel	66	71,294	80,934
<b>Cordón-Herrera (TSK) multi-stage GFS</b>	268	11,073	11,836
<b>Thrift</b>	534	34,063	42,116
2nd order polynomial regression	77 nodes, 15 par.	103,032	45,332
NN 4-5-1	35 par.	86,469	33,105

# 5. Some real-world applications

## OUTLINE

1. Introduction to GFSs
2. GFSs roadmap and milestones
3. Evolutionary tuning of FRBSs
4. Classical GFS learning approaches
5. Some real-world applications
6. Advanced GFS approaches
7. Conclusions. What's next?

## Fuzzy control of Heating Ventilating and Air Conditioning (HVAC) systems:

R. Alcalá, J.M. Benítez, J. Casillas, O. Cordon, R. Perez, Fuzzy control of HVAC systems optimised by genetic algorithms, *Appl. Intell.* 18 (2003) 155–177

- **Goal:** multi-criteria optimization of an expert FLC for an HVAC system: reduction of the energy consumption but maintaining the required indoor comfort levels

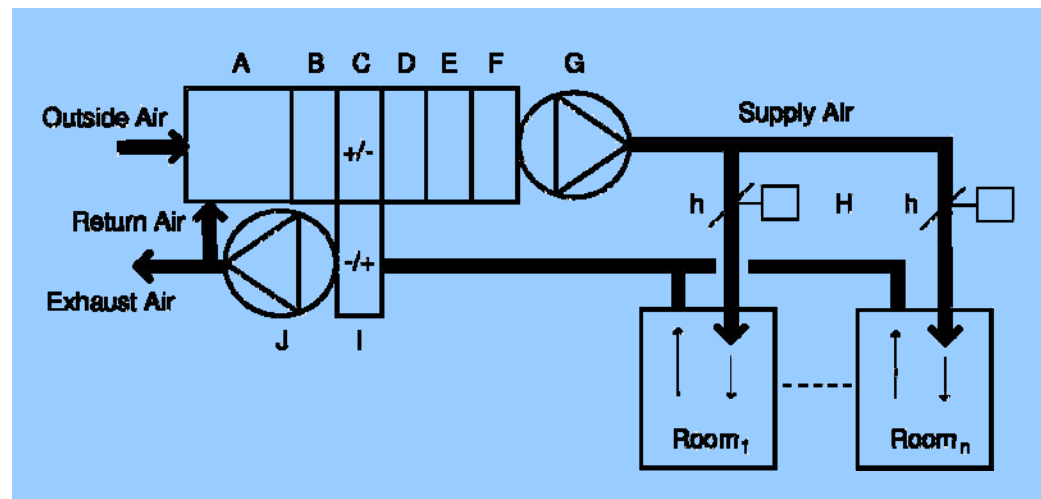

HVAC system structure

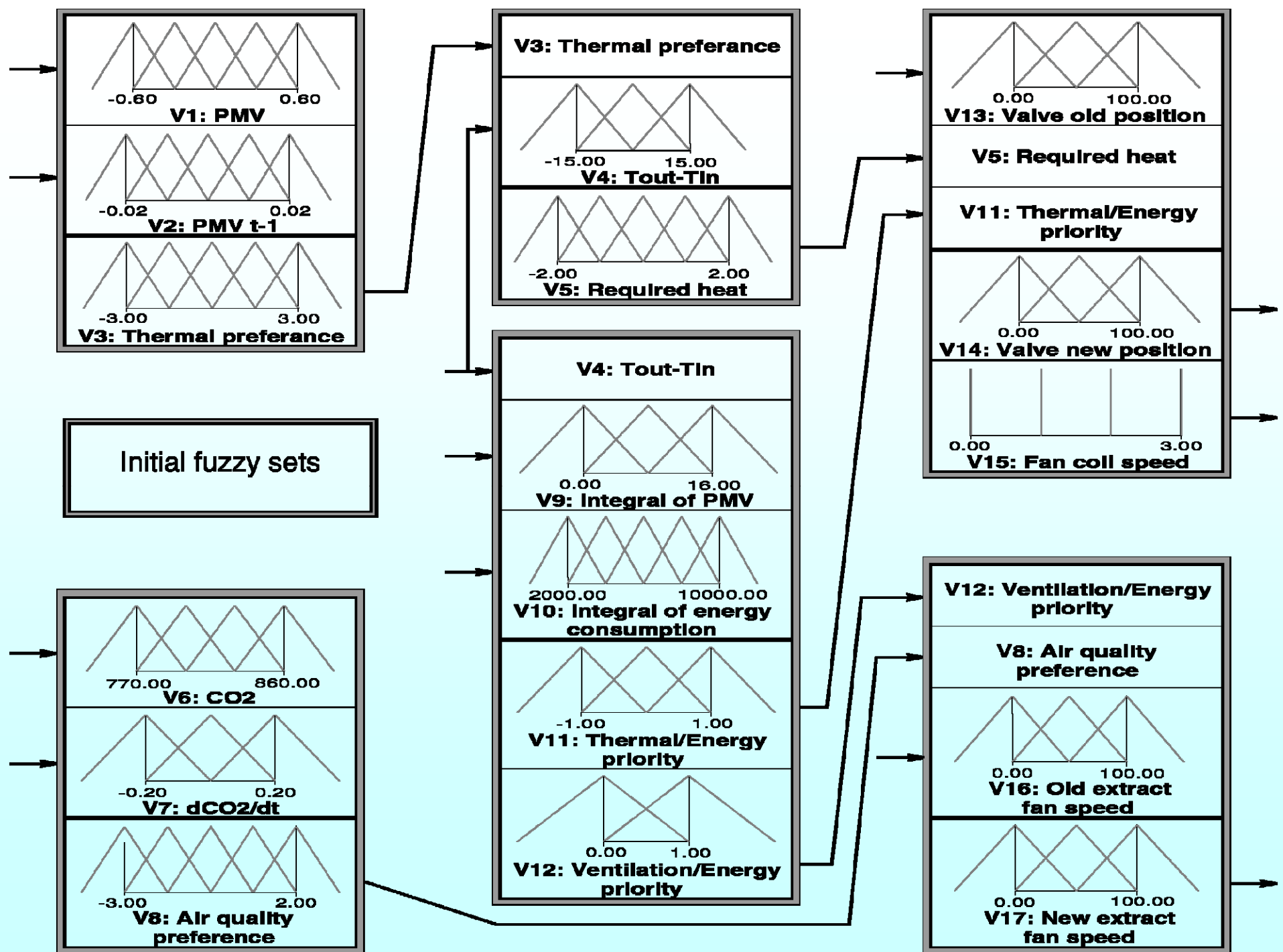

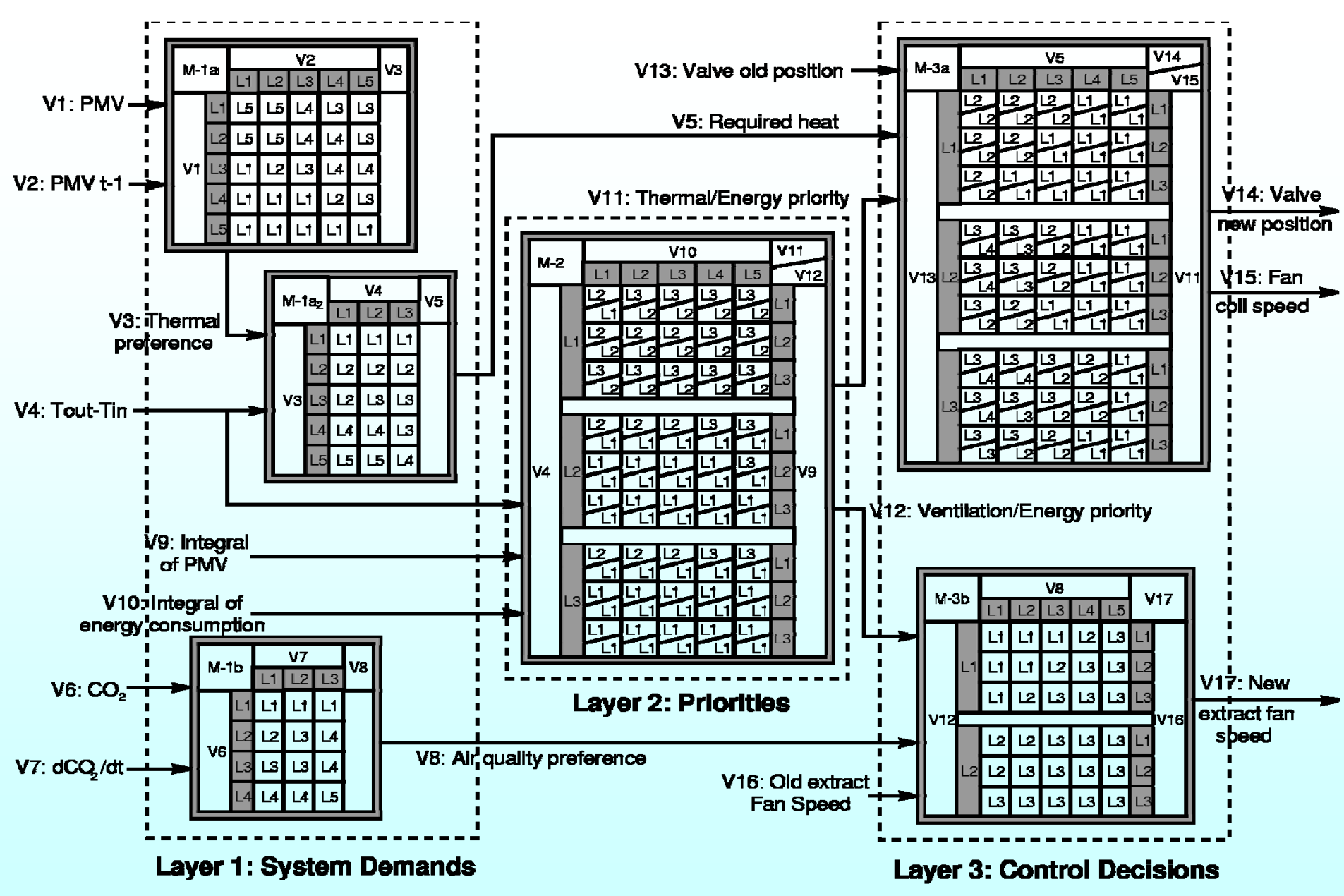

Module 1a<sub>1</sub>: Thermal Demands  
 Module 1a<sub>2</sub>: Thermal Preference  
 Module 1b: Air Quality Demands

Module 2: Energy Priorities  
 Module 3a: Required HVAC System Status  
 Module 3b: Required Ventilation System Status



# 5. Some real-world applications

## OUTLINE

1. Introduction to GFSs
2. GFSs roadmap and milestones
3. Evolutionary tuning of FRBSs
4. Classical GFS learning approaches
5. Some real-world applications
6. Advanced GFS approaches
7. Conclusions. What's next?

## Genetic tuning of the HVAC FLC:

- Goals to optimize:

$O_1$  Upper thermal comfort limit <sup>3</sup>: *if*  $PMV > 0.5, O_1 = O_1 + (PMV - 0.5)$ .

$O_2$  Lower thermal comfort limit: *if*  $PMV < -0.5, O_2 = O_2 + (-PMV - 0.5)$ .

$O_3$  IAQ requirement: *if*  $CO_2 \text{ conc.} > 800ppm, O_3 = O_3 + (CO_2 - 800)$ .

$O_4$  Energy consumption:  $O_4 = O_4 + \text{Power at time } t$ .

$O_5$  System stability:  $C_5 = C_5 + \text{System change from time } t \text{ to } (t - 1)$ .

- Hence, the fitness function is multi-criteria. In this case, an aggregation approach is preferred to a Pareto-based one since:

- Weight values are provided by the human experts defining the importance of each objective
- The search space is smaller
- Quicker GAs can be designed

$$F(x) = w_1 \cdot f_1(x) + \mathbf{K} + w_n \cdot f_n(x)$$

# 5. Some real-world applications

## OUTLINE

1. Introduction to GFSs
2. GFSs roadmap and milestones
3. Evolutionary tuning of FRBSs
4. Classical GFS learning approaches
5. **Some real-world applications**
6. Advanced GFS approaches
7. Conclusions. What's next?

## Genetic tuning of the HVAC FLC (2):

- **Problem restriction:** the simulation model used to evaluate the performance of a DB definition takes 3-4 minutes
- An efficient genetic tuning methodology is mandatory:
  - **Local adjustment** of each membership function definition parameter
  - **GA with quick convergence:** steady-state (just 2000 evaluations will take around 4 days)
  - **Small population size** (31 individuals)
- Real-coded steady-state GA:
  - Two parents are selected and crossed over (max-min-arithmetical) and mutated (Michalewicz), obtaining four offspring
  - The two best of them compete with the two worst individuals in the population to enter into it
  - A restart is applied if the GA has stagnated

# 5. Some real-world applications

## OUTLINE

1. Introduction to GFSs
2. GFSs roadmap and milestones
3. Evolutionary tuning of FRBSs
4. Classical GFS learning approaches
5. **Some real-world applications**
6. Advanced GFS approaches
7. Conclusions. What's next?

## Genetic tuning of the HVAC FLC (3):

- **Coding scheme:**  $n$  variables and  $L_i$  linguistic terms

$$C_i = (a_1^i, b_1^i, c_1^i, K, a_{L_i}^i, b_{L_i}^i, c_{L_i}^i), i = 1, K, n$$

$$C = C_1 C_2 K C_n$$

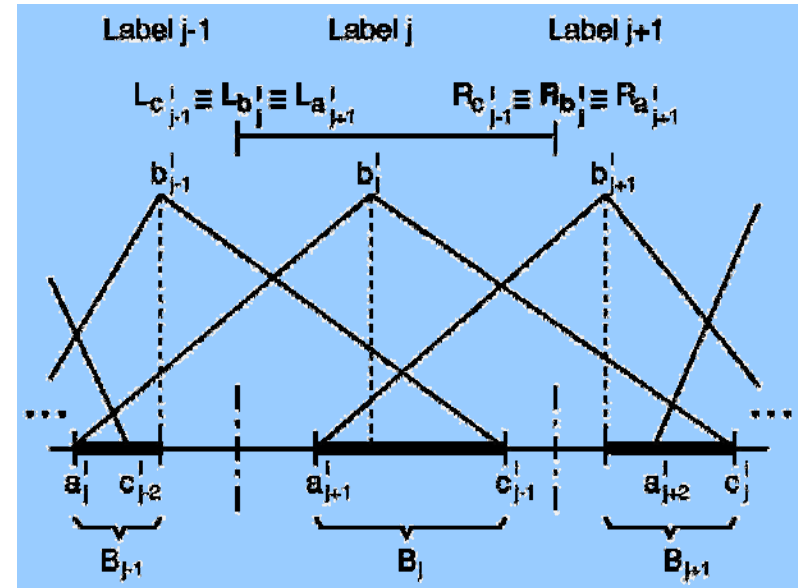

# 5. Some real-world applications

## OUTLINE

1. Introduction to GFSs
2. GFSs roadmap and milestones
3. Evolutionary tuning of FRBSs
4. Classical GFS learning approaches
5. **Some real-world applications**
6. Advanced GFS approaches
7. Conclusions. What's next?

## Obtained results:

MODEL	#R	PMV>0.5		PMV<-0.5		CO <sub>2</sub>		Energy		Stability	
		<i>O</i> <sub>1</sub>	%	<i>O</i> <sub>2</sub>	%	<i>O</i> <sub>3</sub>	%	<i>O</i> <sub>4</sub>	%	<i>O</i> <sub>5</sub>	%
Goals ( <i>g<sub>i</sub></i> )	–	1.0	–	1	–	7	–	2000000	–	1000	–
ON-OFF	–	0.0	–	0	–	0	–	3206400	–	1136	–
FLC	172	0.0	–	0	–	0	–	2901686	9.50	1505	-32.48
Considering Data Base tuning											
DB 1	172	0.0	–	0	–	0	–	2575949	19.66	1115	1.85
DB 2	172	0.0	–	0	–	0	–	2587326	19.31	1077	5.19
DB 3	172	0.0	–	0	–	0	–	2596875	19.01	1051	7.48

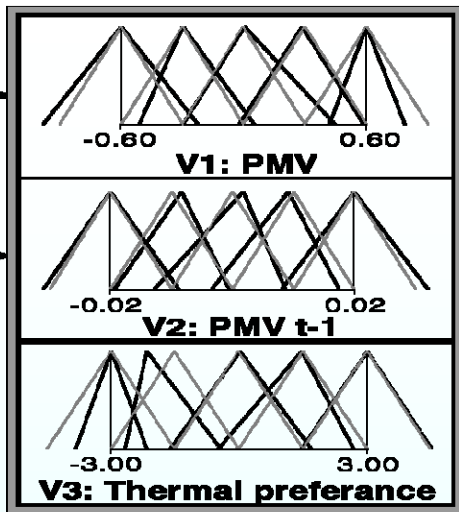

— Initial fuzzy sets  
 — Tuned fuzzy sets

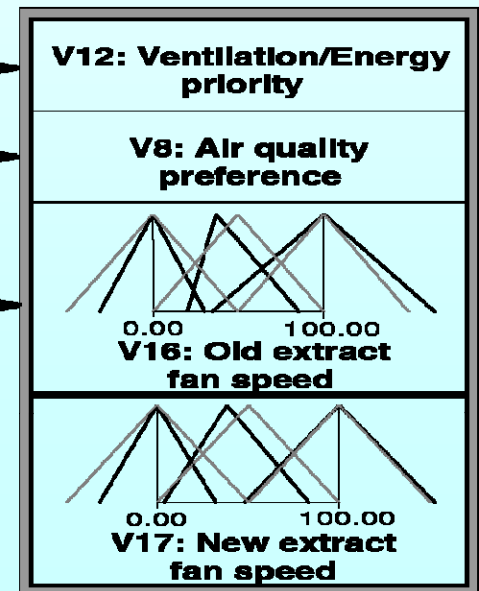
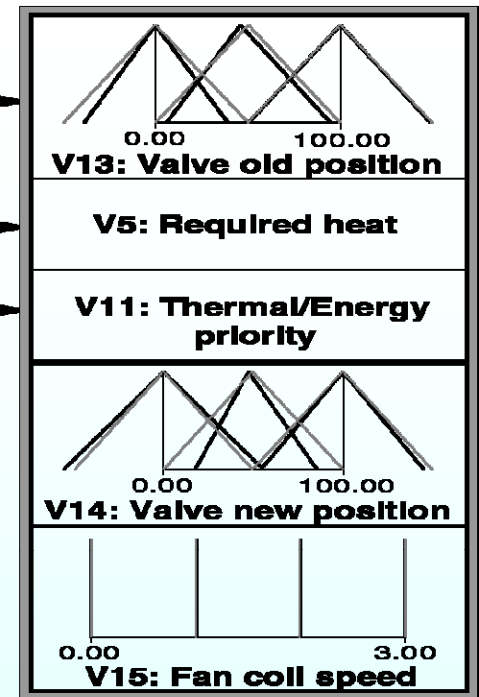
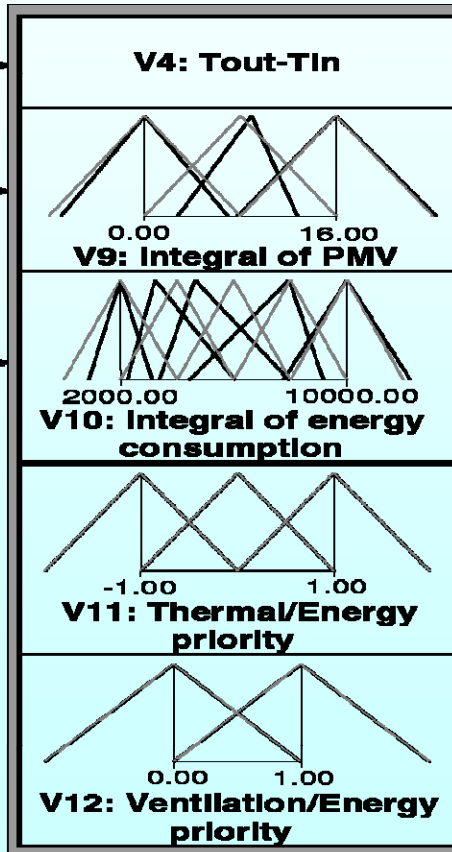
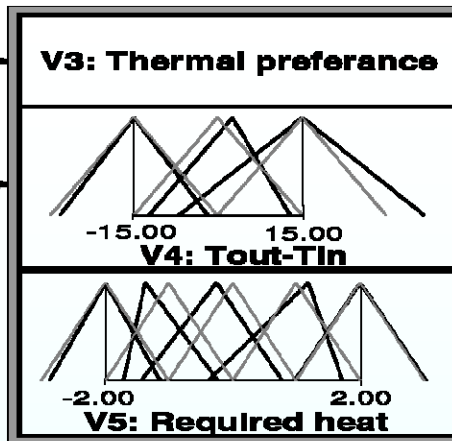
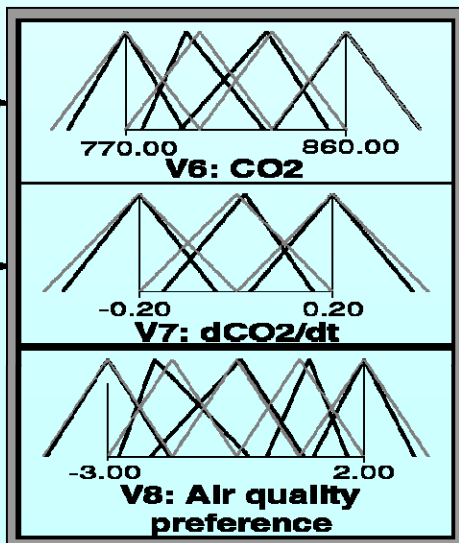

# 6. Advanced GFS approaches

## OUTLINE

1. Introduction to GFSs
2. GFSs roadmap and milestones
3. Evolutionary tuning of FRBSs
4. Classical GFS learning approaches
5. Some real-world applications
- 6. Advanced GFS approaches**
7. Conclusions. What's next?

## New learning schemes

- KB derivation through *a priori* genetic DB learning
- Coevolutionary GFSs
- Incremental Learning

## Interpretability-Accuracy trade-off

- Multi-objective genetic learning and selection of fuzzy rules
- New fuzzy model structures. Combined parameter learning and rule selection
- Advanced tuning approaches

# 6. Advanced GFS approaches

## OUTLINE

1. Introduction to GFSs
2. GFSs roadmap and milestones
3. Evolutionary tuning of FRBSs
4. Classical GFS learning approaches
5. Some real-world applications
- 6. Advanced GFS approaches**
7. Conclusions. What's next?

## KB derivation through *a priori* genetic DB learning:

- GFS based on the decomposition of the learning problem in two **intertwined** stages:
  - Learning of the DB
  - Derivation of the RB
- The DB learning algorithm **wraps** the RB derivation method. The quality of each candidate DB is given by the performance of the whole KB
- Advantages (with respect to the joint DB+RB generation):
  - Reduction of the search space
  - More chances to find optimal solutions

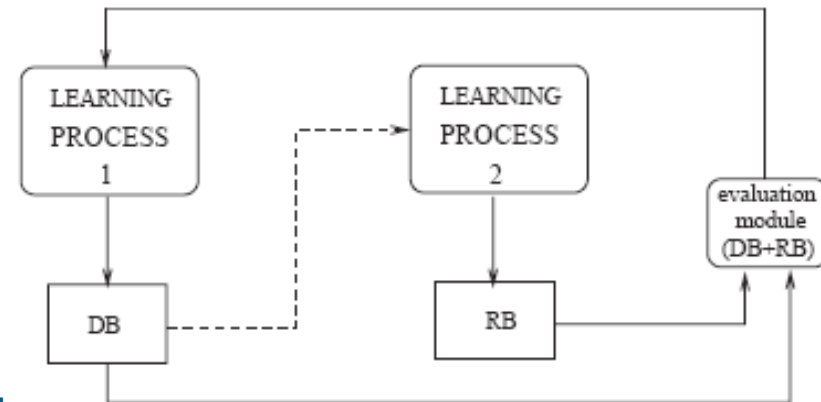

# 6. Advanced GFS approaches

## OUTLINE

1. Introduction to GFSs
2. GFSs roadmap and milestones
3. Evolutionary tuning of FRBSs
4. Classical GFS learning approaches
5. Some real-world applications
6. **Advanced GFS approaches**
7. Conclusions. What's next?

- The GA used to learn the DB can consider any of the following components:
  - The variable domain (scaling factor allowing a brief enlargement)
  - The non-linear scaling function for each fuzzy partition including areas with different "sensitivity" in the variable domain
  - The number of labels per variable (granularity)
  - The membership function shapes
- **The rule generation method must be quick**, since the evaluation of each DB definition requires its run
- Due to this, ad-hoc data-driven methods are usually considered, such as Wang y Mendel's



# 6. Advanced GFS approaches

## OUTLINE

1. Introduction to GFSs
2. GFSs roadmap and milestones
3. Evolutionary tuning of FRBSs
4. Classical GFS learning approaches
5. Some real-world applications
- 6. Advanced GFS approaches**
7. Conclusions. What's next?

## Non-linear scaling function for context definition:

$$f: [-1,1] \rightarrow [-1,1] \quad f(x) = \text{sign}(x) \cdot |x|^a \quad \text{with } a > 0$$

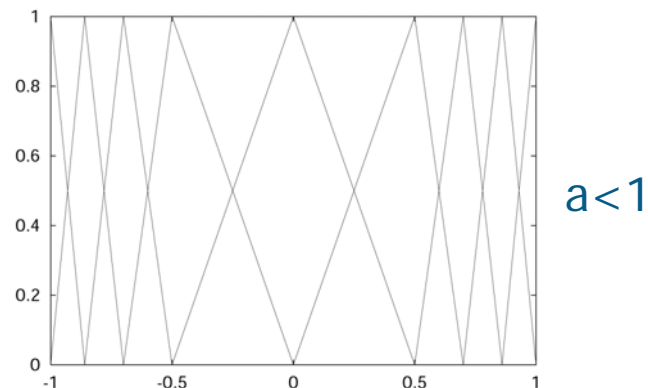
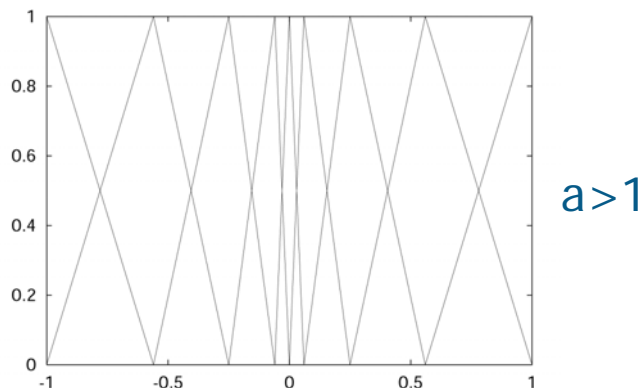
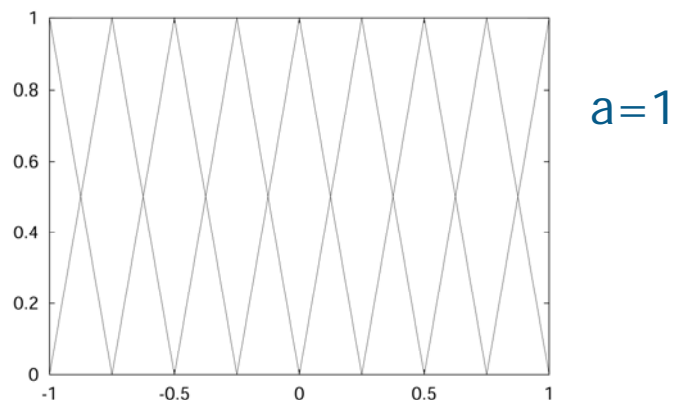

# 6. Advanced GFS approaches

## OUTLINE

1. Introduction to GFSs
2. GFSs roadmap and milestones
3. Evolutionary tuning of FRBSs
4. Classical GFS learning approaches
5. Some real-world applications
- 6. Advanced GFS approaches**
7. Conclusions. What's next?

## Non-linear scaling function for context definition:

- That scaling function is good for symmetrical fuzzy partitions
- We add a new parameter to distinguish non-linearities with asymmetric shape ( $S \in \{0,1\}$ )

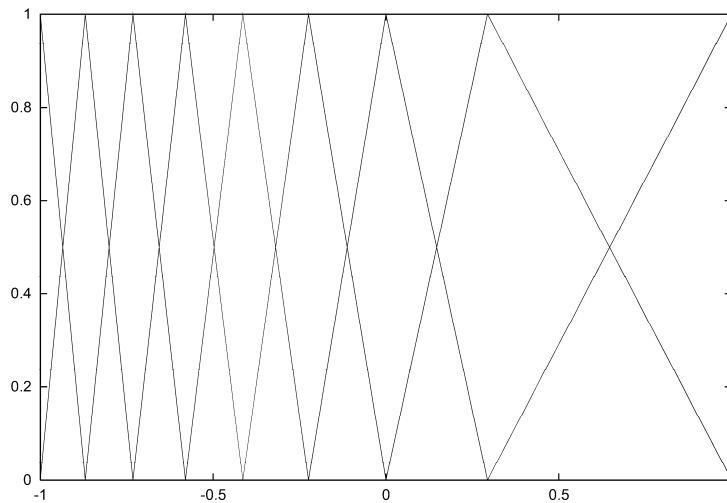

$S=1, a>1$

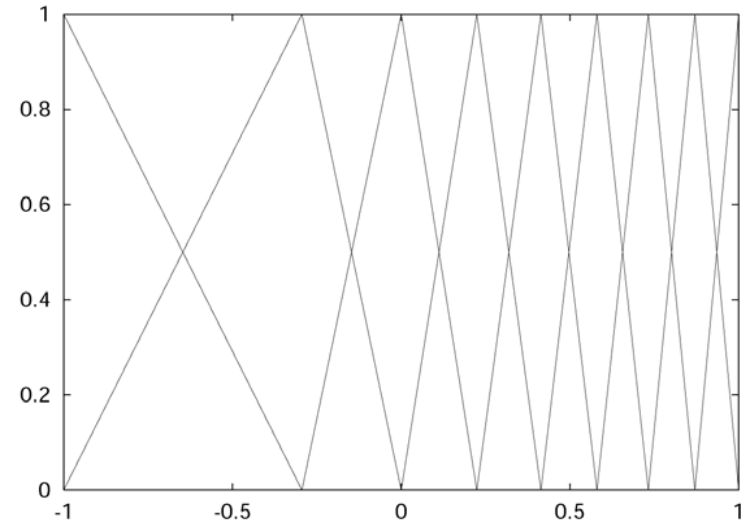

$S=1, a<1$

# 6. Advanced GFS approaches

## OUTLINE

1. Introduction to GFSs
2. GFSs roadmap and milestones
3. Evolutionary tuning of FRBSs
4. Classical GFS learning approaches
5. Some real-world applications
6. **Advanced GFS approaches**
7. Conclusions. What's next?

## Chromosome structure:

- Scaling factors ( $C_1$ ):  $C_1 = (R_1, R_2, \dots, R_N)$ ;  $R_i = (r_i^{\text{inf}}, r_i^{\text{sup}})$

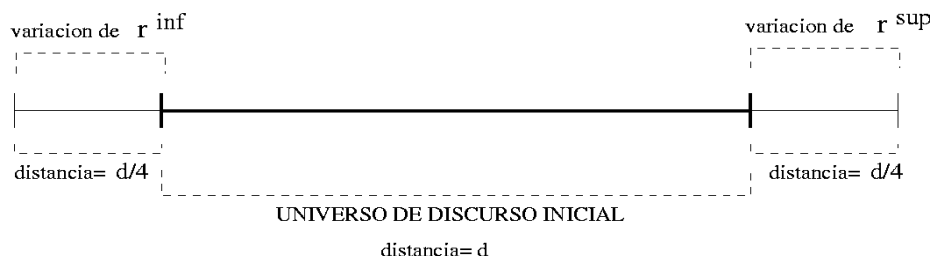

- Sensibility parameters ( $C_2$ ):  $C_2 = (a_1, a_2, \dots, a_N, S_1, S_2, \dots, S_N)$

- Granularity ( $C_3$ ):  $C_3 = (E_1, E_2, \dots, E_N)$   
(integer coding)

- Membership function shapes ( $C_4$ ):

$$C_{4i} = (V1_{i1}, V2_{i1}, V3_{i1}, \dots, V1_{iE}, V2_{iE}, V3_{iE})$$

$$C_4 = (C_{41}, C_{42}, \dots, C_{4N})$$

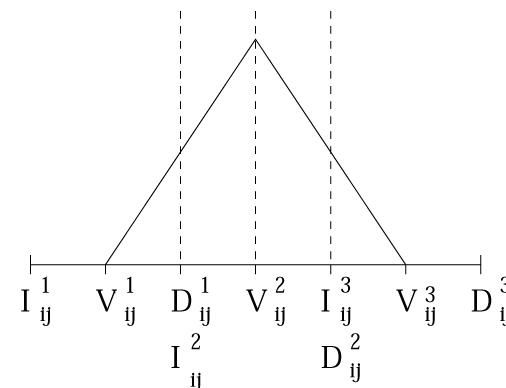

# 6. Advanced GFS approaches

## OUTLINE

1. Introduction to GFSs
2. GFSs roadmap and milestones
3. Evolutionary tuning of FRBSs
4. Classical GFS learning approaches
5. Some real-world applications
- 6. Advanced GFS approaches**
7. Conclusions. What's next?

## DB learning options:

### BASIC OPTIONS:

- Only linear scaling functions (variable domains):  $C = C_1 = (R_1, R_2, \dots, R_N)$
- Only sensibility parameters:  $C = C_2 = (a_1, a_2, \dots, a_N)$  or  
 $C = C_2' = (a_1, a_2, \dots, a_N, S_1, S_2, \dots, S_N)$
- Only granularity:  $C = C_3 = (E_1, E_2, \dots, E_N)$
- Only membership function shapes:  $C = C_4 = (C_{41}, C_{42}, \dots, C_{4N})$

### COMBINATIONS:

- Scaling factors + Granularity:  $C = (C_1, C_3)$
- Non-linear scaling functions + membership functions:  $C = (C_2, C_4)$
- ...

# 6. Advanced GFS approaches

## OUTLINE

1. Introduction to GFSs
2. GFSs roadmap and milestones
3. Evolutionary tuning of FRBSs
4. Classical GFS learning approaches
5. Some real-world applications
- 6. Advanced GFS approaches**
7. Conclusions. What's next?

## Chromosome evaluation:

- Build the DB from the parameters encoded in the chromosome
- Run the RB generation on that DB definition
- Compute the performance measure ( $MSE_{tra}$ , classification error or control error) of the obtained KB (DB+RB)
- To improve the generalization capability in modeling/classification, KBs with a large number of rules (NR) can be slightly penalized:

$$F(C) = \omega_1 \cdot MSE_{tra} + \omega_2 \cdot NR$$

with  $\omega_1 = 1$  and  $\omega_2$  computed from the results of the FRBS with the maximum granularity

# 6. Advanced GFS approaches

## OUTLINE

1. Introduction to GFSs
2. GFSs roadmap and milestones
3. Evolutionary tuning of FRBSs
4. Classical GFS learning approaches
5. Some real-world applications
6. **Advanced GFS approaches**
7. Conclusions. What's next?

## Obtained results in the medium voltage line problem:

Method	Granul.	NR	MSE <sub>tra</sub>	MSE <sub>test</sub>
WM	9 9 9 9 9	130	32.337,4	33.504,9
WM + Tun	9 9 9 9 9	130	13.442,5	17.585,7
FJ	9 9 9 9 9	133	17.441,1	21.184,6
	9 9 9 9 9	139	18.654,5	19.112,8
Gr. + m.f. (C <sub>3</sub> +C <sub>4</sub> )	4 3 9 9 9	96	<b>9.163,5</b>	11.121,3
	3 3 9 7 9	68	9.987,7	10.414,1
Scaling factor + Gr + Scal. function 1 (C <sub>1</sub> +C <sub>2</sub> +C <sub>3</sub> )	5 4 9 9 9	<b>65</b>	9.799,3	9.966,9
Scaling factor + Gr + Scal. function 2 (C <sub>1</sub> +C <sub>2</sub> +C <sub>3</sub> )	4 5 9 9 9	82	9.424,2	<b>9.312,9</b>

## OUTLINE

1. Introduction to GFSs
2. GFSs roadmap and milestones
3. Evolutionary tuning of FRBSs
4. Classical GFS learning approaches
5. Some real-world applications
- 6. Advanced GFS approaches**
7. Conclusions. What's next?

## References:

- O. Cordón, F. Herrera, L. Magdalena, P. Villar, A genetic learning process for the scaling factors, granularity and contexts of the fuzzy rule-based system data base, *Inf. Sci.* 136 (1-4) (2001) 85-107
- O. Cordón, F. Herrera, P. Villar, Generating the knowledge base of a fuzzy Rule-based system by the genetic learning of data base. *IEEE TFS* 9 (4) (2001) 667-674
- O. Cordón, F. Herrera, J. De la Montaña, A.M. Sánchez, P. Villar, A prediction system of cardiovascularity diseases using genetic fuzzy rule-based systems. In: F.J. Garijo et al. (Eds.), *Advances in Artificial Intelligence IBERAMIA 2002*, LNCS 2527, Springer, 2002, pp. 381-391

# 6. Advanced GFS approaches

## OUTLINE

1. Introduction to GFSs
2. GFSs roadmap and milestones
3. Evolutionary tuning of FRBSs
4. Classical GFS learning approaches
5. Some real-world applications
- 6. Advanced GFS approaches**
7. Conclusions. What's next?

## Coevolutionary genetic fuzzy systems:

- **Coevolutionary algorithms** are advanced evolutionary techniques proposed to solve decomposable complex problems
- They involve several **species** (populations) that permanently interact among them by a coupled fitness
- In the **cooperative** approach all the species cooperate to build the problem solution
- They are recommendable when:
  - The search space is huge
  - The problem may be decomposable in subcomponents
  - Different coding schemes are used
  - The subcomponents present strong interdependencies



# 6. Advanced GFS approaches

## OUTLINE

1. Introduction to GFSs
2. GFSs roadmap and milestones
3. Evolutionary tuning of FRBSs
4. Classical GFS learning approaches
5. Some real-world applications
- 6. Advanced GFS approaches**
7. Conclusions. What's next?

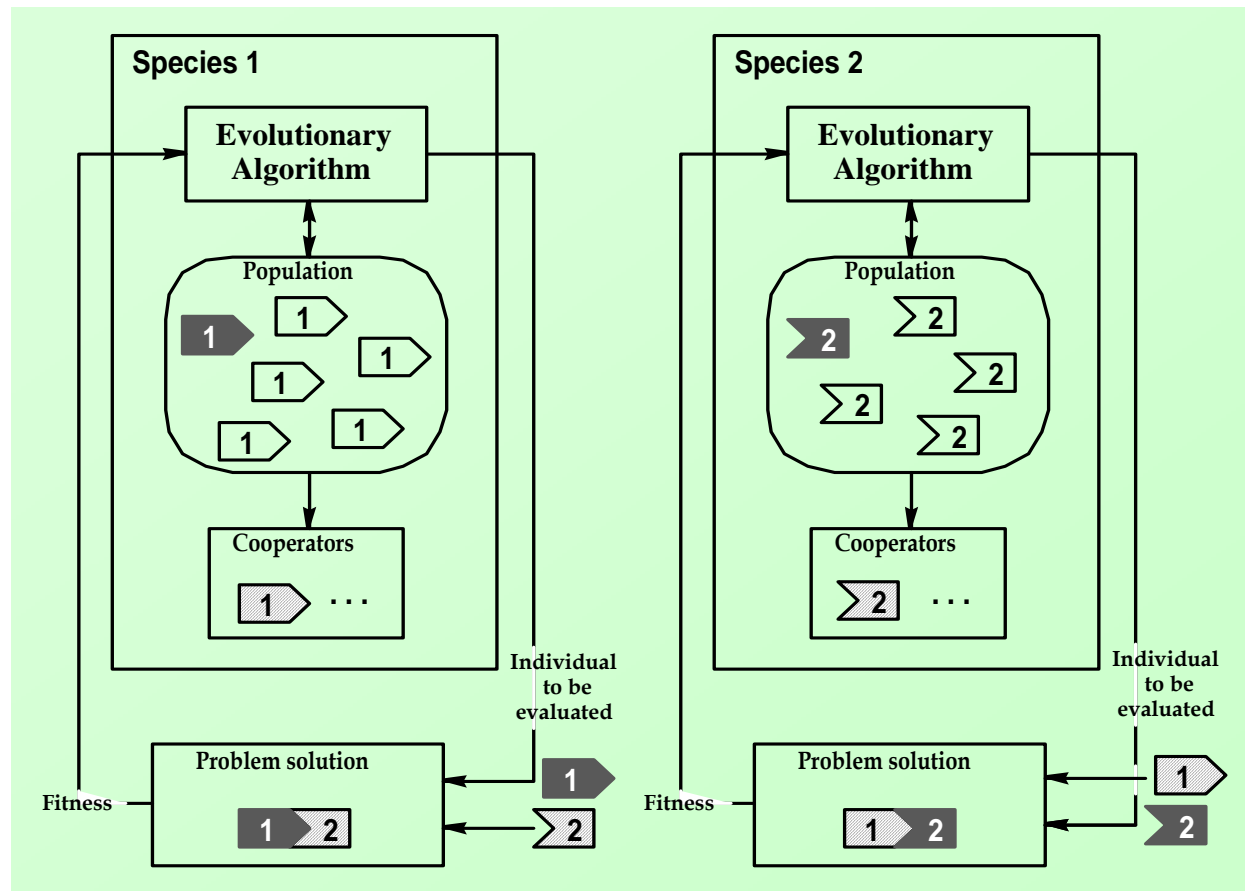

## Cooperative coevolutionary algorithm

# 6. Advanced GFS approaches

## OUTLINE

1. Introduction to GFSs
2. GFSs roadmap and milestones
3. Evolutionary tuning of FRBSs
4. Classical GFS learning approaches
5. Some real-world applications
6. **Advanced GFS approaches**
7. Conclusions. What's next?

## Peña-Reyes' Fuzzy CoCo GFS:

Peña-Reyes, C.A., Sipper, M., Fuzzy CoCo: a cooperative-coevolutionary approach to fuzzy modeling, IEEE TFS 9 (5) (2001) 727-737

- Coevolutionary GFS with two binary-coded species:
  - Data Base: definition of all the membership functions
  - Rule Base: fuzzy rules

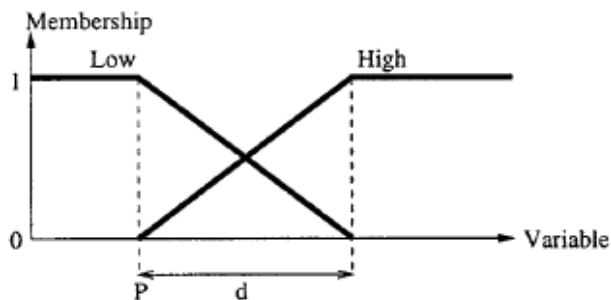

Species 1: Membership functions

Parameter	Values	Bits	Qty	Total bits
$P$	$\{1,2,\dots,8\}$	3	9	27
$d$	$\{1,2,\dots,8\}$	3	9	27
Total				54

Species 2: Rules

Parameter	Values	Bits	Qty	Total bits
$A$	$\{0,1,2,3\}$	2	$9 \times N_r$	$18 \times N_r$
$C$	$\{1,2\}$	1	$N_r + 1$	$N_r + 1$
Total				$19 \times N_r + 1$

- Designed for the **Breast cancer classification problem**: 9 inputs
- Two linguistic labels per variable (genes 1 and 2). **Genes 0 and 3 are used for feature selection at rule level**

# 6. Advanced GFS approaches

## OUTLINE

1. Introduction to GFSs
2. GFSs roadmap and milestones
3. Evolutionary tuning of FRBSs
4. Classical GFS learning approaches
5. Some real-world applications
- 6. Advanced GFS approaches**
7. Conclusions. What's next?

Obtained results:

Rules per system	Neuro-Rule [41]	Single population GA [30]	Fuzzy CoCo	
	best	best	average	best
1	97.36% (4)	97.07% (4)	97.36% (4)	97.36% (4)
2	–	97.36% (4)	97.73% (3.9)	98.54% (5)
3	98.10% (4)	97.80% (6)	97.91% (4.4)	98.54% (4)
4	–	98.24% (7)	98.12% (4.2)	98.68% (5)
5	98.24% (5)	97.95% (7)	98.18% (4.6)	98.83% (5)
6	–	98.10% (9)	98.18% (4.3)	98.83% (5)
7	–	97.95% (8)	98.25% (4.7)	<b>98.98% (5)</b>

- Results from 495 runs
- The number between parenthesis is the number of variables of the most complex rule in the RB

# 6. Advanced GFS approaches

## OUTLINE

1. Introduction to GFSs
2. GFSs roadmap and milestones
3. Evolutionary tuning of FRBSs
4. Classical GFS learning approaches
5. Some real-world applications
- 6. Advanced GFS approaches**
7. Conclusions. What's next?

Obtained results:

Best evolved KB with 2 rules:

		Database								
		$v_1$	$v_2$	$v_3$	$v_4$	$v_5$	$v_6$	$v_7$	$v_8$	$v_9$
$P$		3		1	3	4	5		7	2
$d$		8		3	1	2	2		4	1

**Rule base**

Rule 1    if ( $v_1$  is *Low*) and ( $v_3$  is *Low*) and ( $v_5$  is *Low*)  
            then (*output is benign*)

Rule 2    if ( $v_1$  is *Low*) and ( $v_4$  is *Low*) and ( $v_6$  is *Low*)  
            and ( $v_8$  is *Low*) and ( $v_9$  is *Low*) then (*output*  
            is *benign*)

Default    else (*output is malignant*)

Classification rate: 98.54%

# 6. Advanced GFS approaches

## OUTLINE

1. Introduction to GFSs
2. GFSs roadmap and milestones
3. Evolutionary tuning of FRBSs
4. Classical GFS learning approaches
5. Some real-world applications
- 6. Advanced GFS approaches**
7. Conclusions. What's next?

Obtained results:

Best evolved KB with 7 rules:

		Database								
		$v_1$	$v_2$	$v_3$	$v_4$	$v_5$	$v_6$	$v_7$	$v_8$	$v_9$
$P$		2	1	1	1	6	1	3	5	2
$d$		7	8	4	8	1	4	8	4	1

		Rule base								
Rule 1		if ( $v_1$ is <i>Low</i> ) and ( $v_3$ is <i>Low</i> ) then (output is <i>benign</i> )								
Rule 2		if ( $v_4$ is <i>Low</i> ) and ( $v_6$ is <i>Low</i> ) and ( $v_8$ is <i>Low</i> ) and ( $v_9$ is <i>Low</i> ) then (output is <i>benign</i> )								
Rule 3		if ( $v_1$ is <i>Low</i> ) and ( $v_3$ is <i>High</i> ) and ( $v_5$ is <i>High</i> ) and ( $v_8$ is <i>Low</i> ) and ( $v_9$ is <i>Low</i> ) then (output is <i>benign</i> )								
Rule 4		if ( $v_1$ is <i>Low</i> ) and ( $v_2$ is <i>High</i> ) and ( $v_4$ is <i>Low</i> ) and ( $v_5$ is <i>Low</i> ) and ( $v_8$ is <i>High</i> ) then (output is <i>benign</i> )								
Rule 5		if ( $v_2$ is <i>High</i> ) and ( $v_4$ is <i>High</i> ) then (output is <i>malignant</i> )								
Rule 6		if ( $v_1$ is <i>High</i> ) and ( $v_3$ is <i>High</i> ) and ( $v_6$ is <i>High</i> ) and ( $v_7$ is <i>High</i> ) then (output is <i>malignant</i> )								
Rule 7		if ( $v_2$ is <i>High</i> ) and ( $v_3$ is <i>High</i> ) and ( $v_4$ is <i>Low</i> ) and ( $v_5$ is <i>Low</i> ) and ( $v_7$ is <i>High</i> ) then (output is <i>malignant</i> )								
Default		else (output is <i>malignant</i> )								

Classification rate: 98.98%

# 6. Advanced GFS approaches

## OUTLINE

1. Introduction to GFSs
2. GFSs roadmap and milestones
3. Evolutionary tuning of FRBSs
4. Classical GFS learning approaches
5. Some real-world applications
- 6. Advanced GFS approaches**
7. Conclusions. What's next?

## Incremental learning:

Hoffmann, F., Koo, T.-J., Shakernia, O., Evolutionary design of a helicopter autopilot, In: Advances in Soft Computing - Engineering Design and Manufacturing, Part 3: Intelligent Control, Springer-Verlag, 1999, pp. 201-214

- **GFS that learns TSK fuzzy rules incrementally:**  
IF  $X_1$  IS  $A_1$  AND  $X_2$  IS  $A_2$  ... THEN  $y = C_0 + C_1 \cdot X_1 + C_2 \cdot X_2 + \dots + C_n \cdot X_n$
- The system starts from a single, very simple rule, covering the whole input space and with a linear output
- An evolution strategy is considered to iteratively partition the fuzzy input subspaces, keeping the linear outputs
- Alternatively, new terms are added to the consequent weighted combination to get a non linear mapping in the output

# 6. Advanced GFS approaches

## OUTLINE

1. Introduction to GFSs
2. GFSs roadmap and milestones
3. Evolutionary tuning of FRBSs
4. Classical GFS learning approaches
5. Some real-world applications
6. **Advanced GFS approaches**
7. Conclusions. What's next?

IF  $x_1$  IS  $A_1$  AND  $x_2$  IS  $B_1$  ... THEN  $F = c_0$

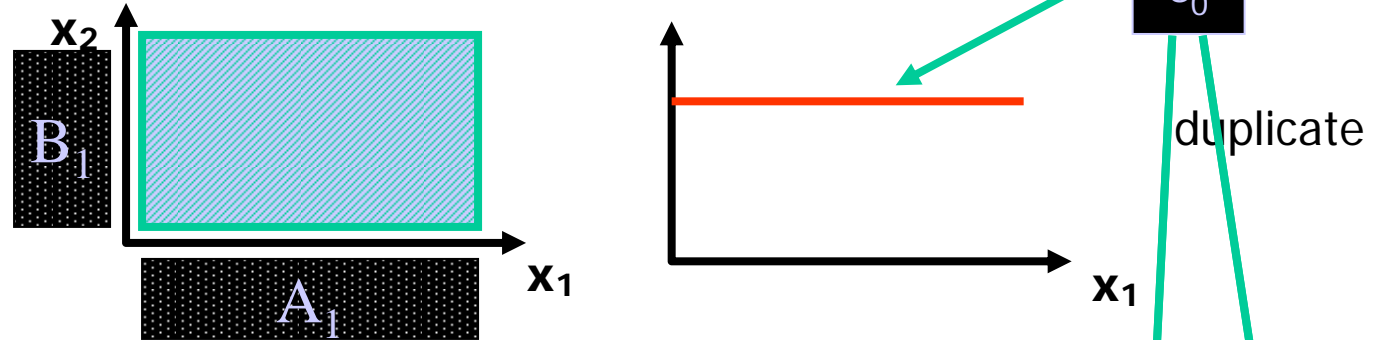

**partition input space along one variable**

IF  $x_1$  IS  $A_1$  AND  $x_2$  IS  $B_1$  ... THEN  $F = c_0^1$

IF  $x_1$  IS  $A_2$  AND  $x_2$  IS  $B_1$  ... THEN  $F = c_0^2$

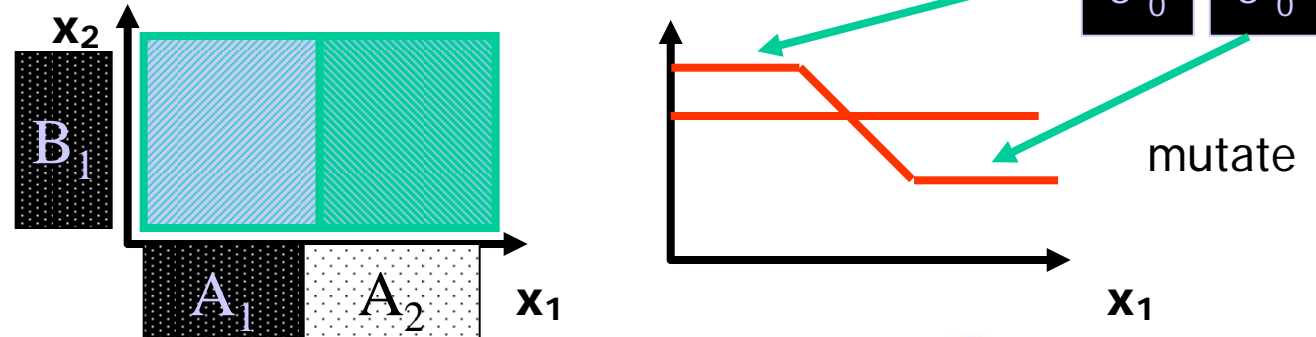

# 6. Advanced GFS approaches

## OUTLINE

1. Introduction to GFSs
2. GFSs roadmap and milestones
3. Evolutionary tuning of FRBSs
4. Classical GFS learning approaches
5. Some real-world applications
6. **Advanced GFS approaches**
7. Conclusions. What's next?

IF  $x_1$  IS  $A_1$  AND  $x_2$  IS  $B_1$  ... THEN  $F = c_0$

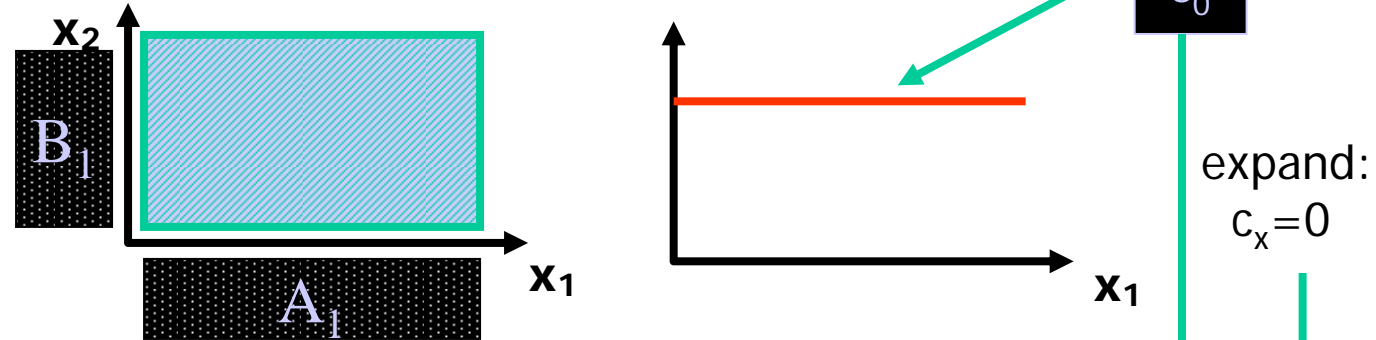

**add a term to the linear output**

IF  $x_1$  IS  $A_1$  AND  $x_2$  IS  $B_1$  ... THEN  $F = c_0 + c_x$

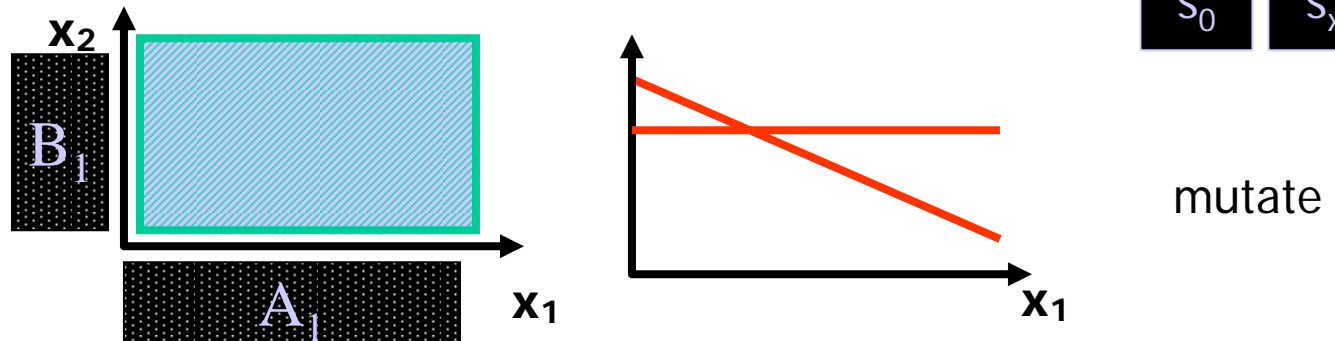



# 6. Advanced GFS approaches

## OUTLINE

1. Introduction to GFSs
2. GFSs roadmap and milestones
3. Evolutionary tuning of FRBSs
4. Classical GFS learning approaches
5. Some real-world applications
6. Advanced GFS approaches
7. Conclusions. What's next?

IF  $x_1$  IS  $A_1$  AND  $x_2$  IS  $B_1$  ... THEN  $F = c_0$

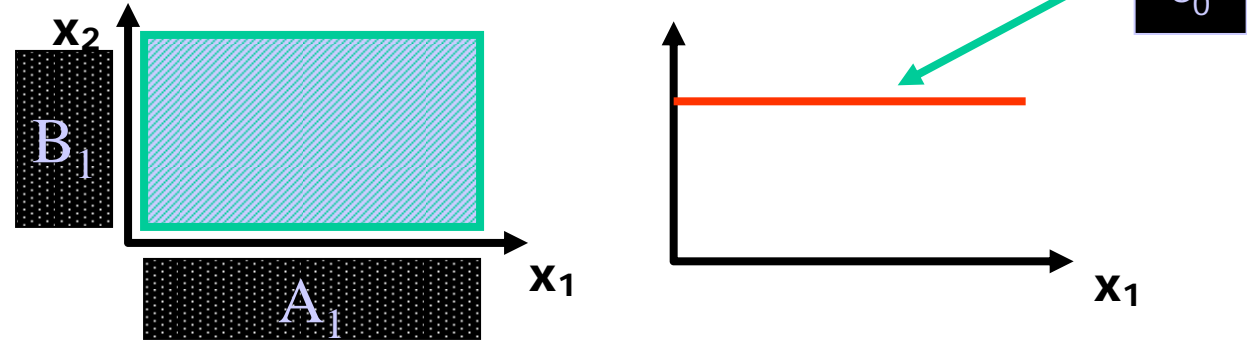

IF  $x_1$  IS  $A_1$  AND  $x_2$  IS  $B_1$  ... THEN  $F = c^1_0 + c^1_x$

IF  $x_1$  IS  $A_2$  AND  $x_2$  IS  $B_1$  ... THEN  $F = c^2_0 + c^2_x$

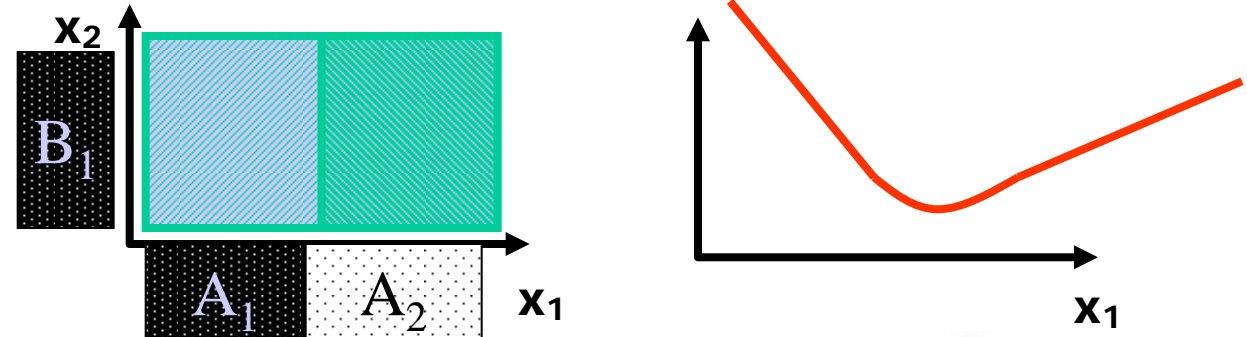
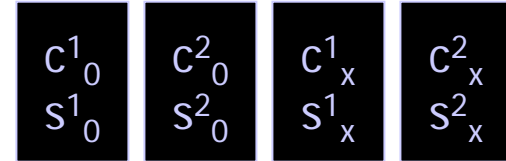

# 6. Advanced GFS approaches

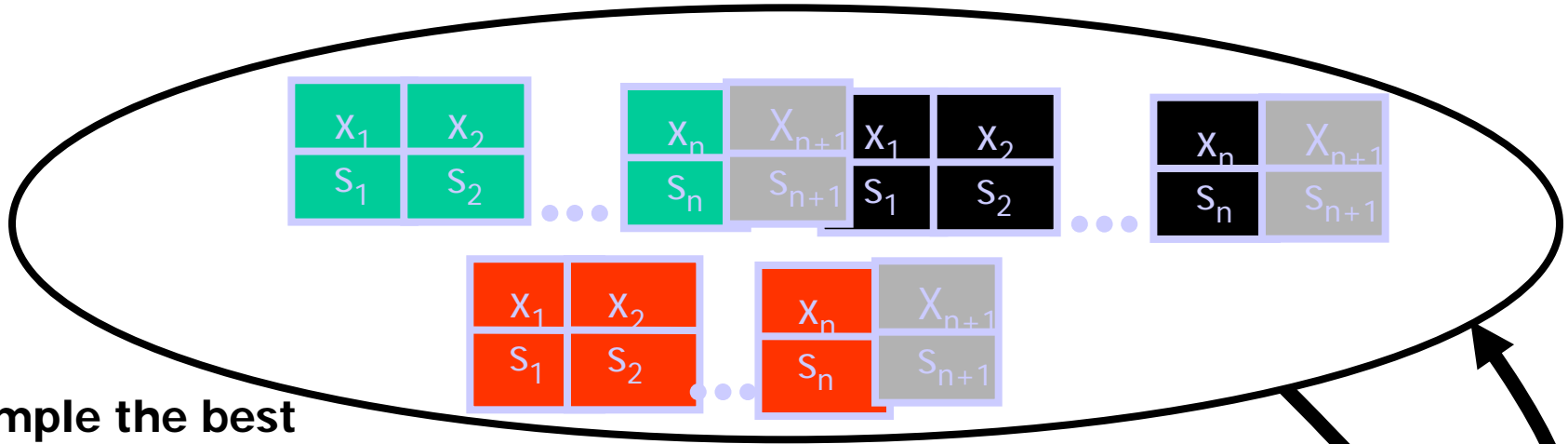

sample the best chromosomes from the current population

evaluate the functional effect of the new gene

select genome expansion with the largest increase in population (or none)

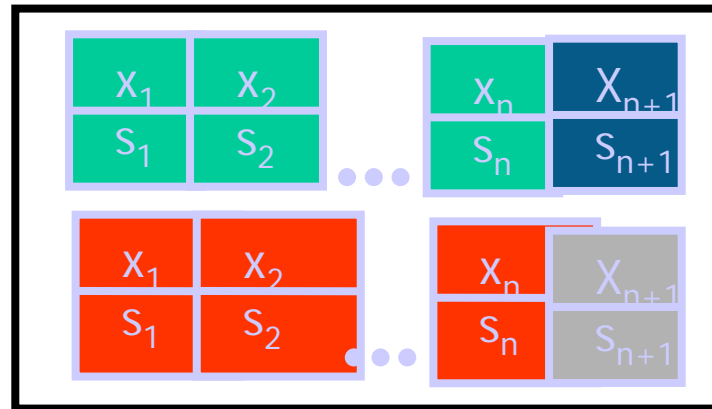

# 6. Advanced GFS approaches

## OUTLINE

1. Introduction to GFSs
2. GFSs roadmap and milestones
3. Evolutionary tuning of FRBSs
4. Classical GFS learning approaches
5. Some real-world applications
6. **Advanced GFS approaches**
7. Conclusions. What's next?

Obtained results in the cart pole problem:

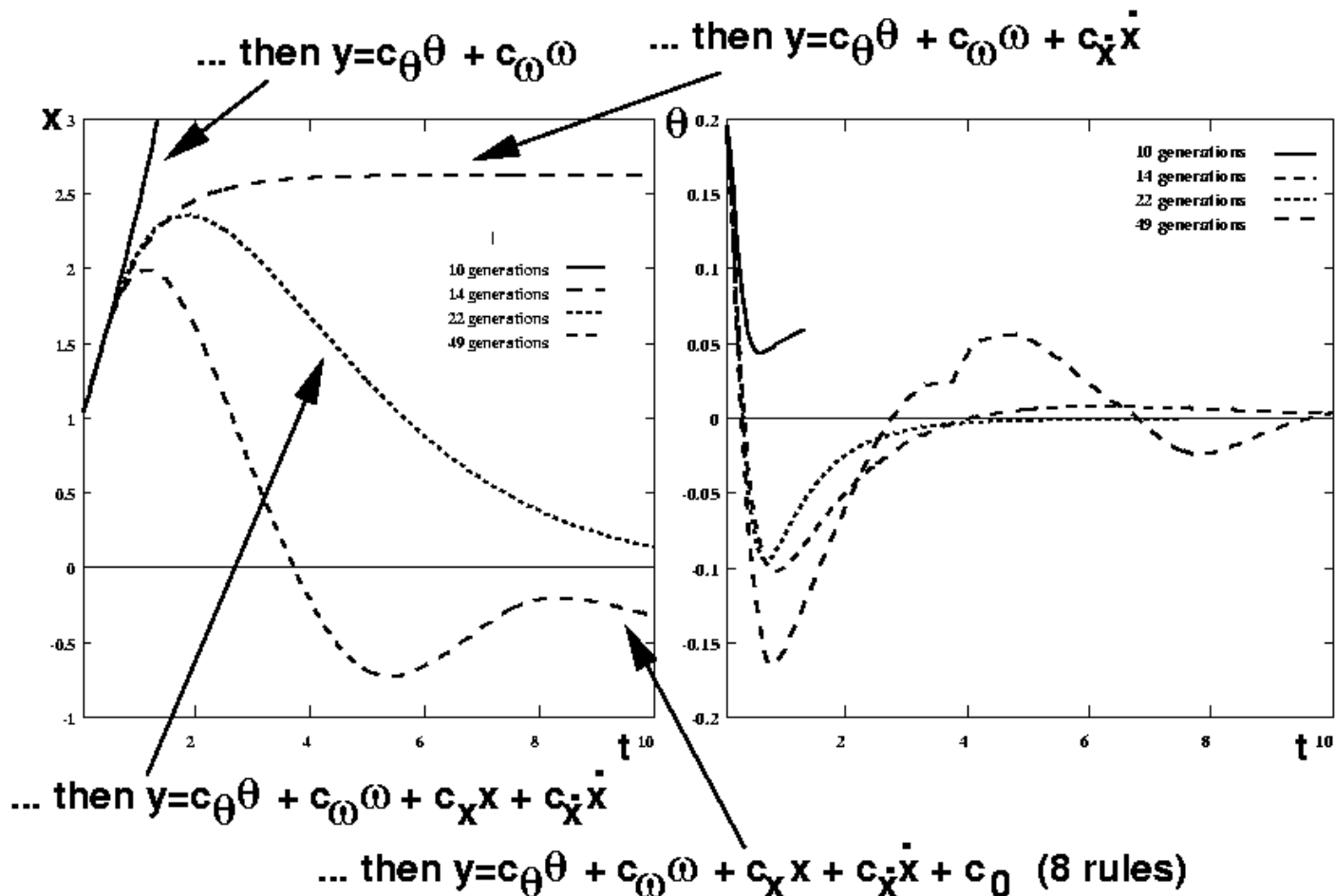

# 6. Advanced GFS approaches

## OUTLINE

1. Introduction to GFSs
2. GFSs roadmap and milestones
3. Evolutionary tuning of FRBSs
4. Classical GFS learning approaches
5. Some real-world applications
6. **Advanced GFS approaches**
7. Conclusions. What's next?

Order of genome expression in the cart pole problem:

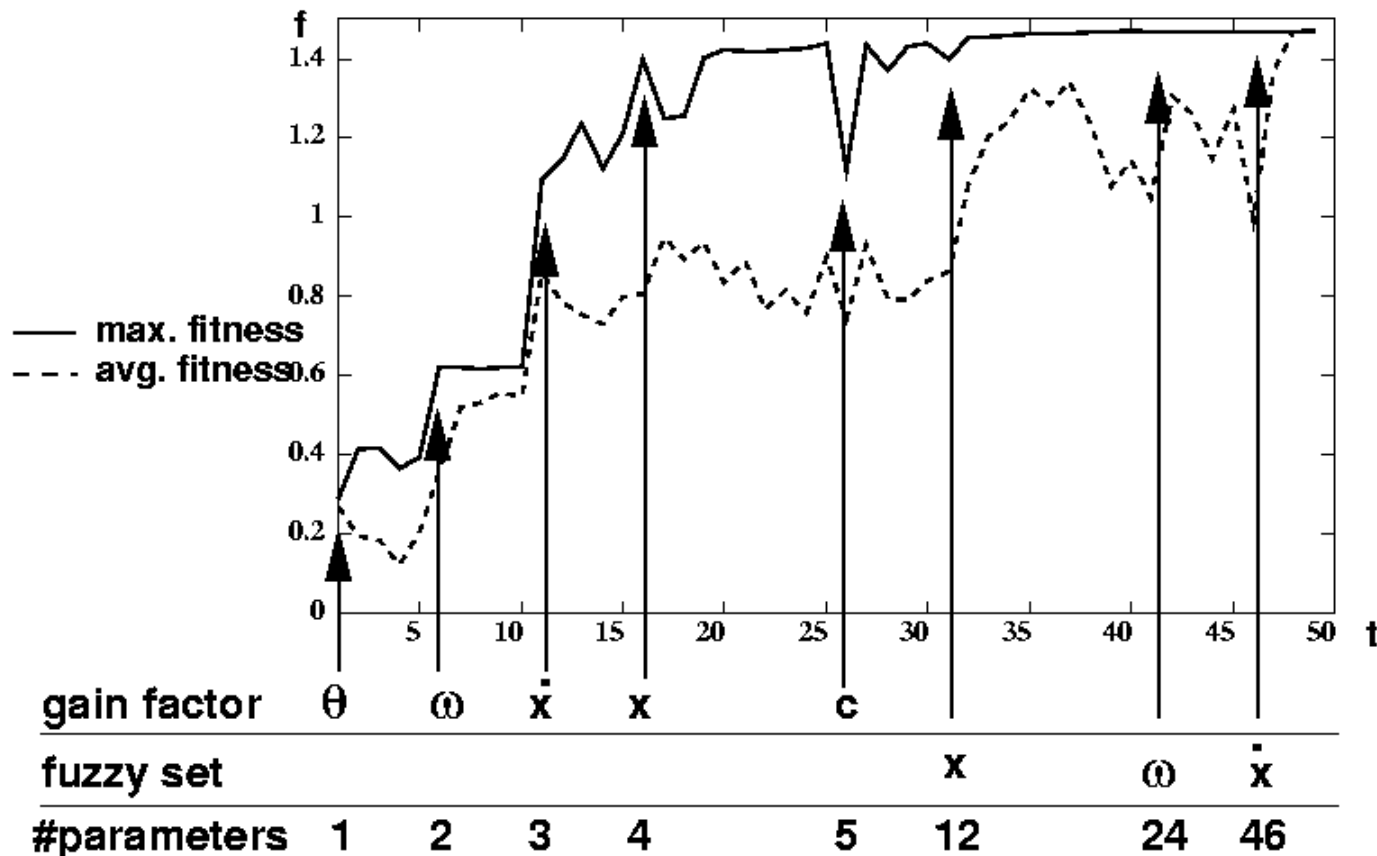

# 6. Advanced GFS approaches

## OUTLINE

1. Introduction to GFSs
2. GFSs roadmap and milestones
3. Evolutionary tuning of FRBSs
4. Classical GFS learning approaches
5. Some real-world applications
6. **Advanced GFS approaches**
7. Conclusions. What's next?

Obtained results in a mobile robot problem:

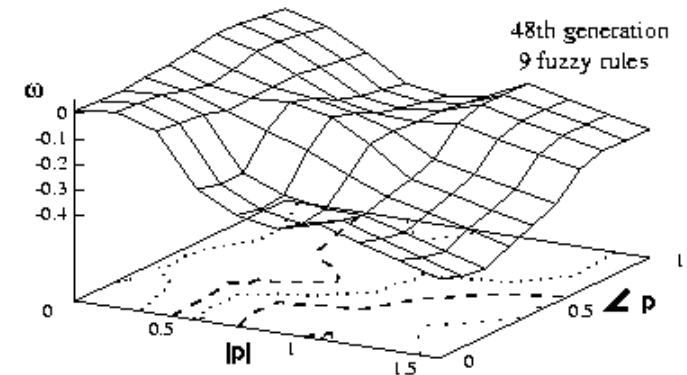
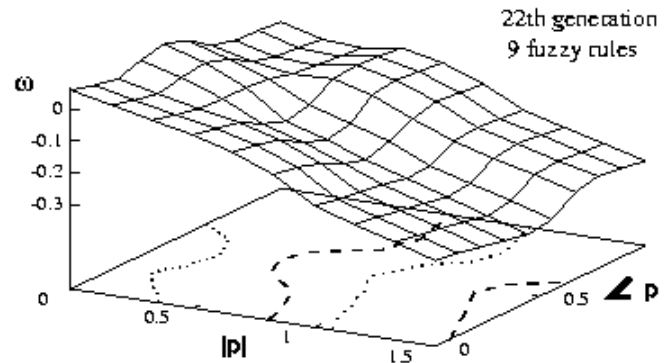
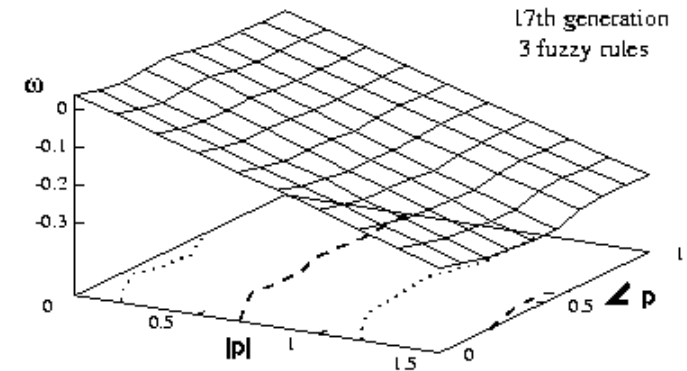
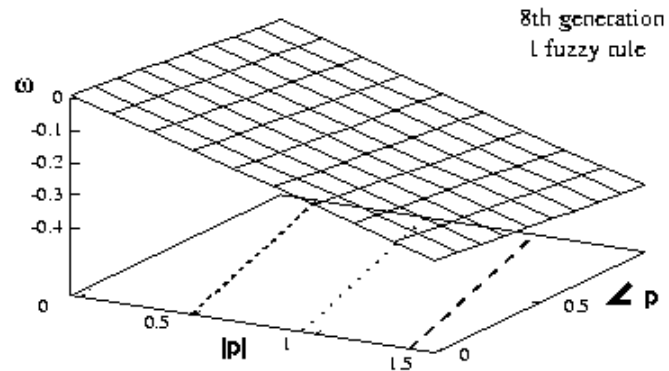

# 6. Advanced GFS approaches

## OUTLINE

1. Introduction to GFSs
2. GFSs roadmap and milestones
3. Evolutionary tuning of FRBSs
4. Classical GFS learning approaches
5. Some real-world applications
- 6. Advanced GFS approaches**
7. Conclusions. What's next?

## Experiments on the real robot:

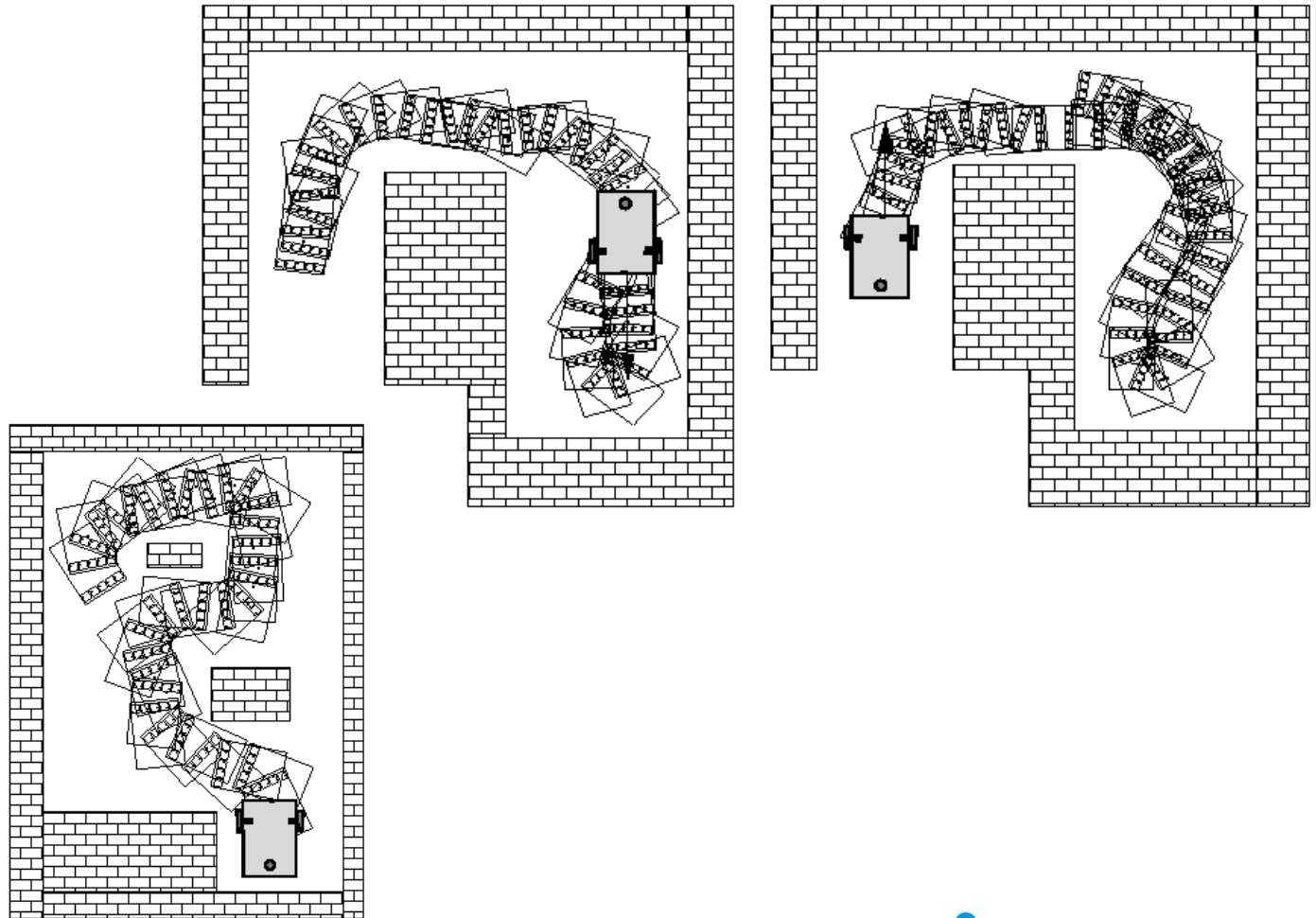

# 6. Advanced GFS approaches

## OUTLINE

1. Introduction to GFSs
2. GFSs roadmap and milestones
3. Evolutionary tuning of FRBSs
4. Classical GFS learning approaches
5. Some real-world applications
- 6. Advanced GFS approaches**
7. Conclusions. What's next?

## New learning schemes

- Learning KBs through *a priori* genetic DB learning
- Coevolutionary GFSs
- Incremental Learning

## Interpretability-Accuracy trade-off

- Multi-objective genetic learning and selection of fuzzy rules
- New fuzzy model structures. Combined parameter learning and rule selection
- Advanced tuning approaches

# 6. Advanced GFS approaches

## OUTLINE

1. Introduction to GFSs
2. GFSs roadmap and milestones
3. Evolutionary tuning of FRBSs
4. Classical GFS learning approaches
5. Some real-world applications
6. **Advanced GFS approaches**
7. Conclusions. What's next?

## Interpretability-accuracy trade-off in fuzzy system design

- Every model must satisfy two basic requirements:
  - **Accuracy:** Actually represent the modeled reality
  - **Interpretability:** Describe the system in a readable way
- To obtain high degrees for both is a contradictory purpose and, in practice, one of the two properties prevails over the other
- A very simple model does not properly represent the system and a complex model is difficult to understand and generalizes badly
- Obtaining accurate and comprehensible fuzzy models/classifiers/controllers is known as the **interpretability-accuracy trade-off**

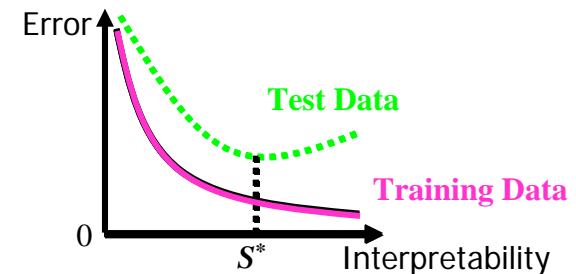
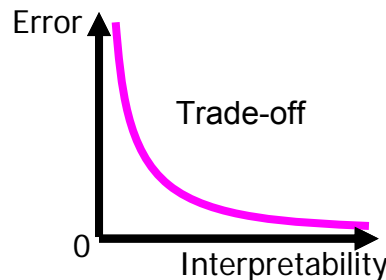



# 6. Advanced GFS approaches

## OUTLINE

1. Introduction to GFSs
2. GFSs roadmap and milestones
3. Evolutionary tuning of FRBSs
4. Classical GFS learning approaches
5. Some real-world applications
6. **Advanced GFS approaches**
7. Conclusions. What's next?

## Multi-objective genetic learning and selection of fuzzy rules:

- **Goal:** To find a large number of fuzzy rule sets with different interpretability-accuracy trade-offs

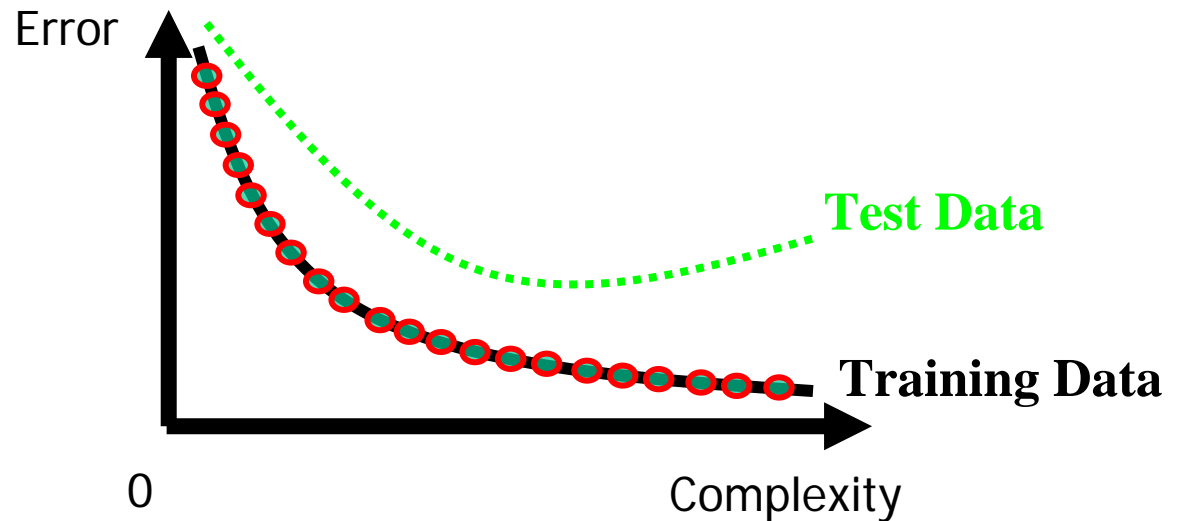

- **Problem:** Classification problems present a large number of input variables → many rule antecedents and huge number of possible Mamdani fuzzy rules

# 6. Advanced GFS approaches

## OUTLINE

1. Introduction to GFSs
2. GFSs roadmap and milestones
3. Evolutionary tuning of FRBSs
4. Classical GFS learning approaches
5. Some real-world applications
6. **Advanced GFS approaches**
7. Conclusions. What's next?

## Two-stage genetic fuzzy system:

H. Ishibuchi, T. Yamamoto, Fuzzy rule selection by multi-objective genetic local search algorithms and rule evaluation measures in data mining, FSS 141 (2004) 59-88

1. **Heuristic Rule Extraction:** A pre-specified number of candidate fuzzy rules of different granularity are extracted from numerical data using a heuristic rule evaluation criterion

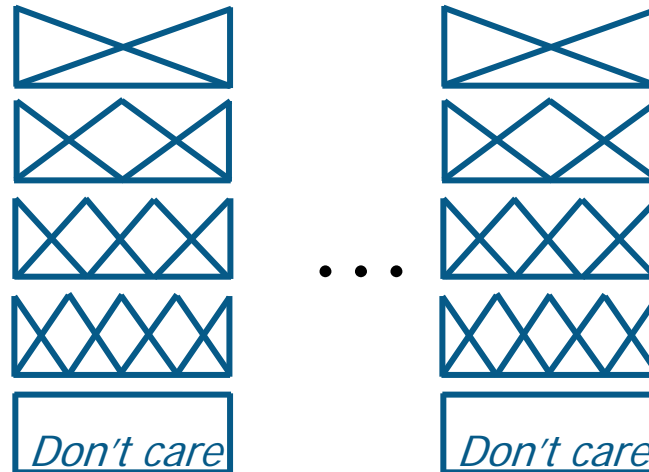

# of possible rules:

$$x_1 \quad \dots \quad x_n$$
$$(14+1) \times \dots \times (14+1) = 15^n$$

# 6. Advanced GFS approaches

## OUTLINE

1. Introduction to GFSs
2. GFSs roadmap and milestones
3. Evolutionary tuning of FRBSs
4. Classical GFS learning approaches
5. Some real-world applications
- 6. Advanced GFS approaches**
7. Conclusions. What's next?

2. **Genetic Rule Selection:** A small fuzzy rule set is selected from the extracted candidate rules using a multi-objective GA

- Binary coding scheme

- **Objectives:**

- $f_1(S)$  : Number of correctly classified patterns by  $S$
- $f_2(S)$  : Number of selected rules in  $S$
- $f_3(S)$  : Total number of antecedent conditions in  $S$

- **Multicriteria approaches:**

1. Two-objective approach: Maximize  $f_1(S)$  and minimize  $f_2(S)$
2. Weighted sum of the two objectives: Maximize  $w_1 \cdot f_1(S) - w_2 \cdot f_2(S)$
3. Three-objective approach: Maximize  $f_1(S)$  and minimize  $f_2(S)$ ,  $f_3(S)$
4. Weighted sum of the three objectives: Max  $w_1 \cdot f_1(S) - w_2 \cdot f_2(S) - w_3 \cdot f_3(S)$

# 6. Advanced GFS approaches

## OUTLINE

1. Introduction to GFSs
2. GFSs roadmap and milestones
3. Evolutionary tuning of FRBSs
4. Classical GFS learning approaches
5. Some real-world applications
- 6. Advanced GFS approaches**
7. Conclusions. What's next?

## Example of the obtained results (Diabetes):

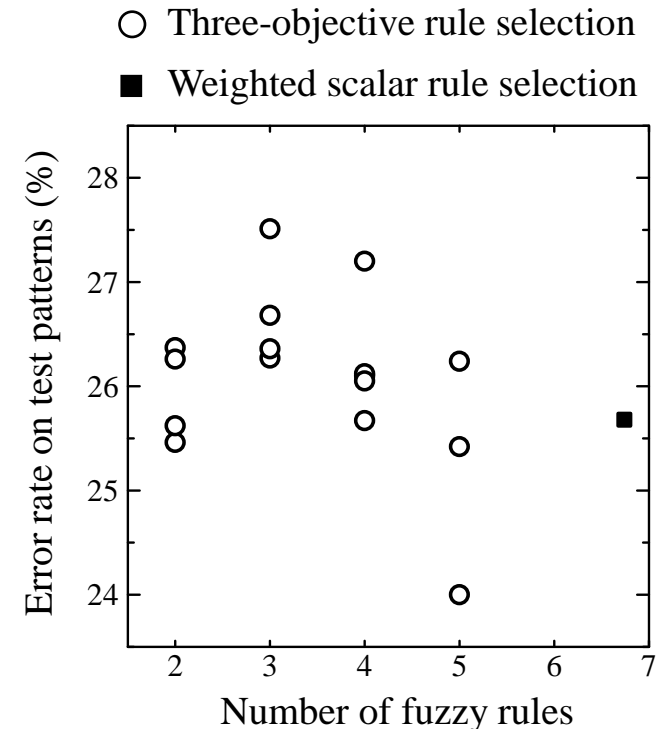
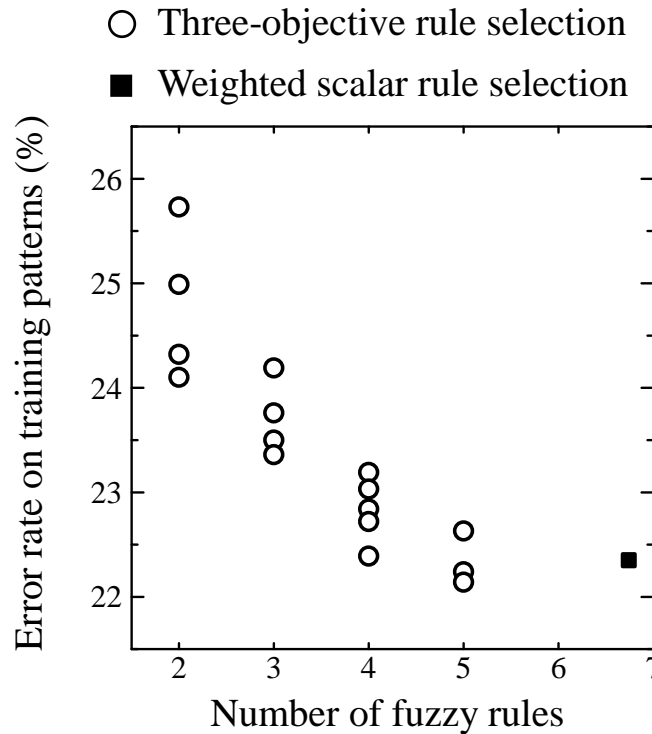

A single rule set is obtained by the weighted sum approach

# 6. Advanced GFS approaches

## OUTLINE

1. Introduction to GFSs
2. GFSs roadmap and milestones
3. Evolutionary tuning of FRBSs
4. Classical GFS learning approaches
5. Some real-world applications
- 6. Advanced GFS approaches**
7. Conclusions. What's next?

## Example of the obtained results (Diabetes):

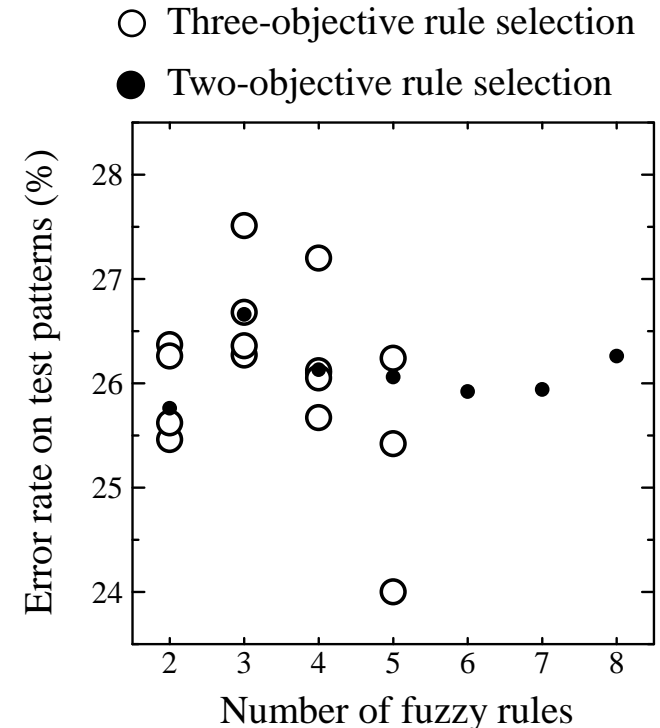
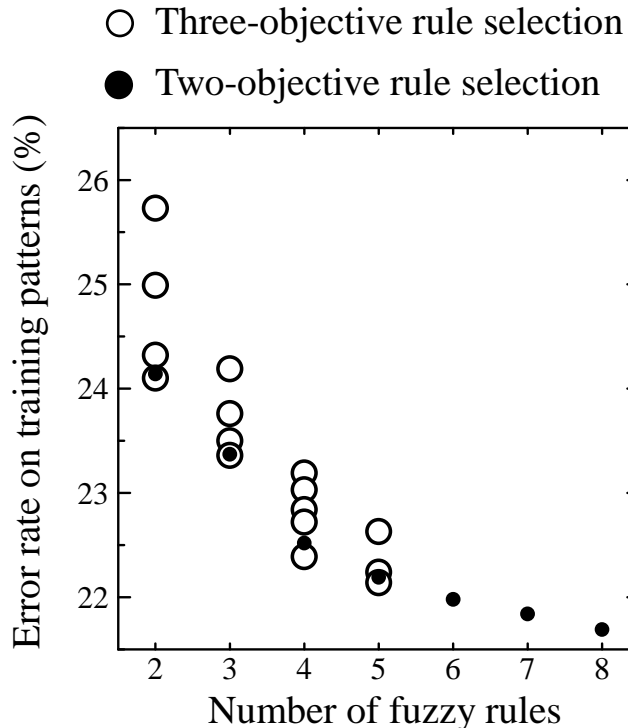

The effect in the rule increase is not clear

# 6. Advanced GFS approaches

## OUTLINE

1. Introduction to GFSs
2. GFSs roadmap and milestones
3. Evolutionary tuning of FRBSs
4. Classical GFS learning approaches
5. Some real-world applications
- 6. Advanced GFS approaches**
7. Conclusions. What's next?

## Example of the obtained results (Sonar):

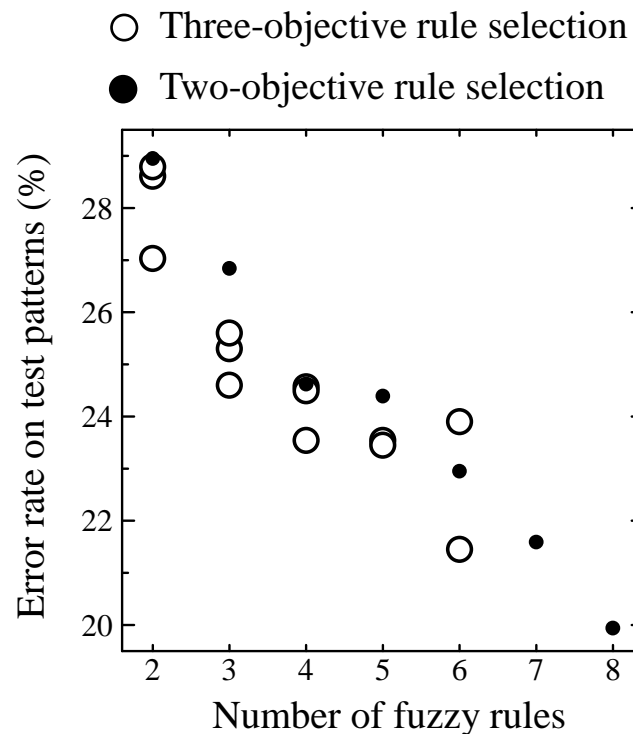
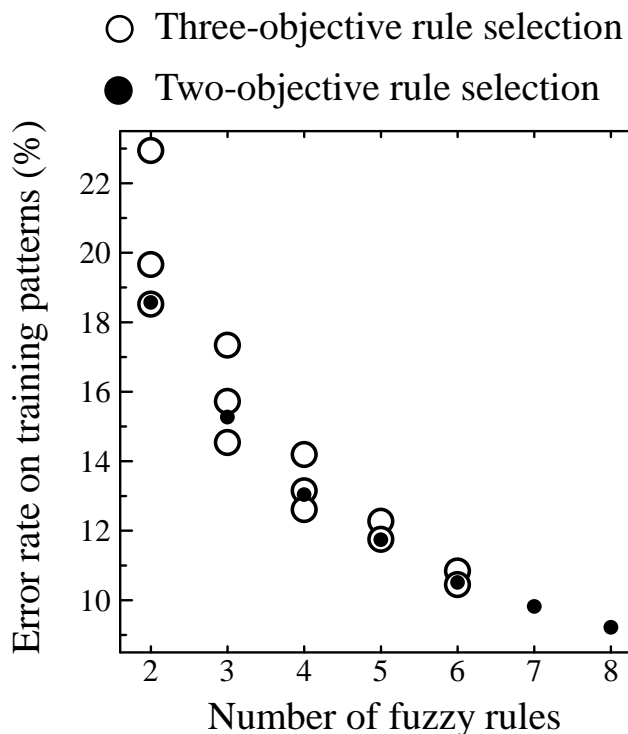

The generalization ability is increased by increasing the number of fuzzy rules (i.e., the overfitting is not observed)

# 6. Advanced GFS approaches

## OUTLINE

1. Introduction to GFSs
2. GFSs roadmap and milestones
3. Evolutionary tuning of FRBSs
4. Classical GFS learning approaches
5. Some real-world applications
6. **Advanced GFS approaches**
7. Conclusions. What's next?

## References:

- H. Ishibuchi, T. Murata, I.B. Türksen, Single-objective and two-objective genetic algorithms for selecting linguistic rules for pattern classification problems, *FSS* 89 (1997) 135–150
- H. Ishibuchi, T. Nakashima, T. Murata, Three-objective genetics-based machine learning for linguistic rule extraction, *Inform. Sci.* 136 (1–4) (2001) 109–133
- H. Ishibuchi, T. Yamamoto, Rule weight specification in fuzzy rule-based classification systems, *IEEE TFS* 13 (4) (2005) 428-435

**H. Ishibuchi, T. Nakashima, M. Nii, Classification and Modeling with Linguistic Information Granules. Advanced Approaches to Linguistic Data Mining. Springer (2005)**



# 6. Advanced GFS approaches

## OUTLINE

1. Introduction to GFSs
2. GFSs roadmap and milestones
3. Evolutionary tuning of FRBSs
4. Classical GFS learning approaches
5. Some real-world applications
- 6. Advanced GFS approaches**
7. Conclusions. What's next?

## New fuzzy model structures:

- Use of linguistic hedges:

**IF  $X_1$  is  $I_{h_{X_1}}$   $A_1$  AND ... AND  $X_n$  IS  $I_{h_{X_n}}$   $A_n$  THEN  $Y$  IS  $I_{h_Y}$   $B$**

- Use of more than one consequent for each rule:

**IF  $X_1$  is  $A_1$  AND ... AND  $X_n$  IS  $A_n$  THEN  $Y$  IS  $\{B_1, \dots, B_c\}$**

- Use of weighted rules:

**IF  $X_1$  is  $A_1$  AND ... AND  $X_n$  IS  $A_n$  THEN  $Y$  IS  $B$  with  $[w]$**

The creation of this new fuzzy rule models require sophisticated (genetic) learning approaches and selection methods to promote rule cooperation

R. Alcalá, J. Alcalá-Fdez, J. Casillas, O. Cordón, F. Herrera, Hybrid learning models to get the interpretability-accuracy trade-off in fuzzy modelling, *Soft Computing* 10 (9) (2006) 717-734



# 6. Advanced GFS approaches

## OUTLINE

1. Introduction to GFSs
2. GFSs roadmap and milestones
3. Evolutionary tuning of FRBSs
4. Classical GFS learning approaches
5. Some real-world applications
- 6. Advanced GFS approaches**
7. Conclusions. What's next?

## References:

- J. Casillas, O. Cordón, F. Herrera, L. Magdalena (Eds.). Springer-Verlag, 2003

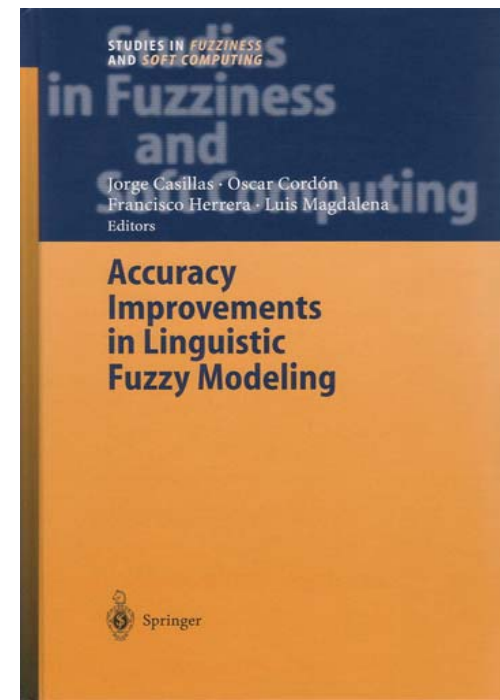
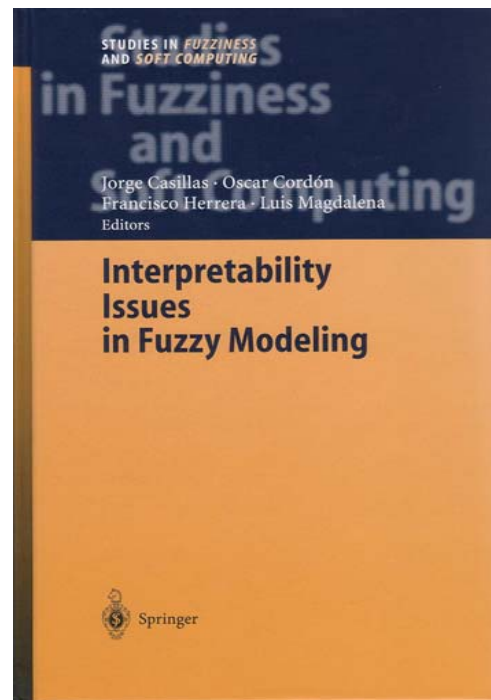

# 6. Advanced GFS approaches

## OUTLINE

1. Introduction to GFSs
2. GFSs roadmap and milestones
3. Evolutionary tuning of FRBSs
4. Classical GFS learning approaches
5. Some real-world applications
6. **Advanced GFS approaches**
7. Conclusions. What's next?

## Joint weight derivation-rule selection process:

R. Alcalá, J. Casillas, O. Cordón, A. González, F. Herrera, A genetic rule weighting and selection process for fuzzy control of Heating, Ventilating and Air Conditioning Systems, Engineering Applications of Artificial Intelligence 18 (3) (2005) 279-296

GA with a two-level coding scheme:  $C = (C_1, C_2)$

- $C_1$  (selection): binary chromosome of length  $m$  (# of simple Mamdani-type rules derived in a first learning stage)
- $C_2$  (weights): real-coded chromosome of length  $m$ . Each gene encodes the weight ( $[0,1]$ ) for the corresponding rule
- Genetic operators: cooperatively working in the two-level structure:

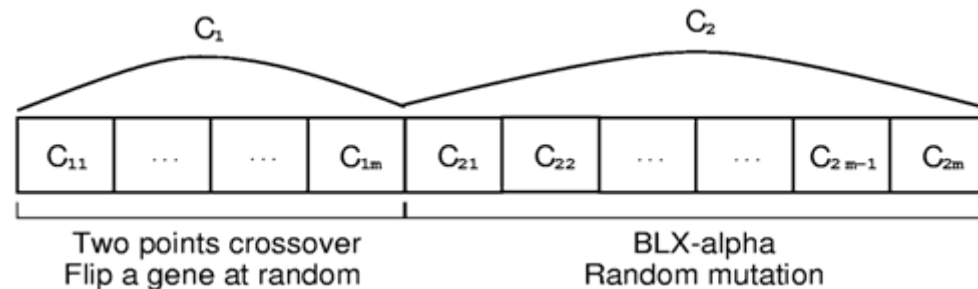

# 6. Advanced GFS approaches

## OUTLINE

1. Introduction to GFSs
2. GFSs roadmap and milestones
3. Evolutionary tuning of FRBSs
4. Classical GFS learning approaches
5. Some real-world applications
6. **Advanced GFS approaches**
7. Conclusions. What's next?

Obtained results for the HVAC FLC tuning problem:

MODEL	#R	PMV>0.5		PMV<-0.5		CO <sub>2</sub>		Energy		Stability	
		O <sub>1</sub>	%	O <sub>2</sub>	%	O <sub>3</sub>	%	O <sub>4</sub>	%	O <sub>5</sub>	%
Goals ( <i>g<sub>i</sub></i> )	—	1.0	—	1	—	7	—	2000000	—	1000	—
ON-OFF	—	0.0	—	0	—	0	—	3206400	—	1136	—
FLC	172	0.0	—	0	—	0	—	2901686	9.50	1505	-32.48
Considering Data Base tuning											
DB 3	172	0.0	—	0	—	0	—	2596875	19.01	1051	7.48
Considering rule weights and rule selection											
Seed 1	123	0.9	—	0	—	0	—	2769621	13.62	970	14.61
Seed 2	102	0.7	—	0	—	0	—	2731798	14.80	942	17.08
Seed 3	103	0.2	—	0	—	0	—	2766135	13.73	936	17.61

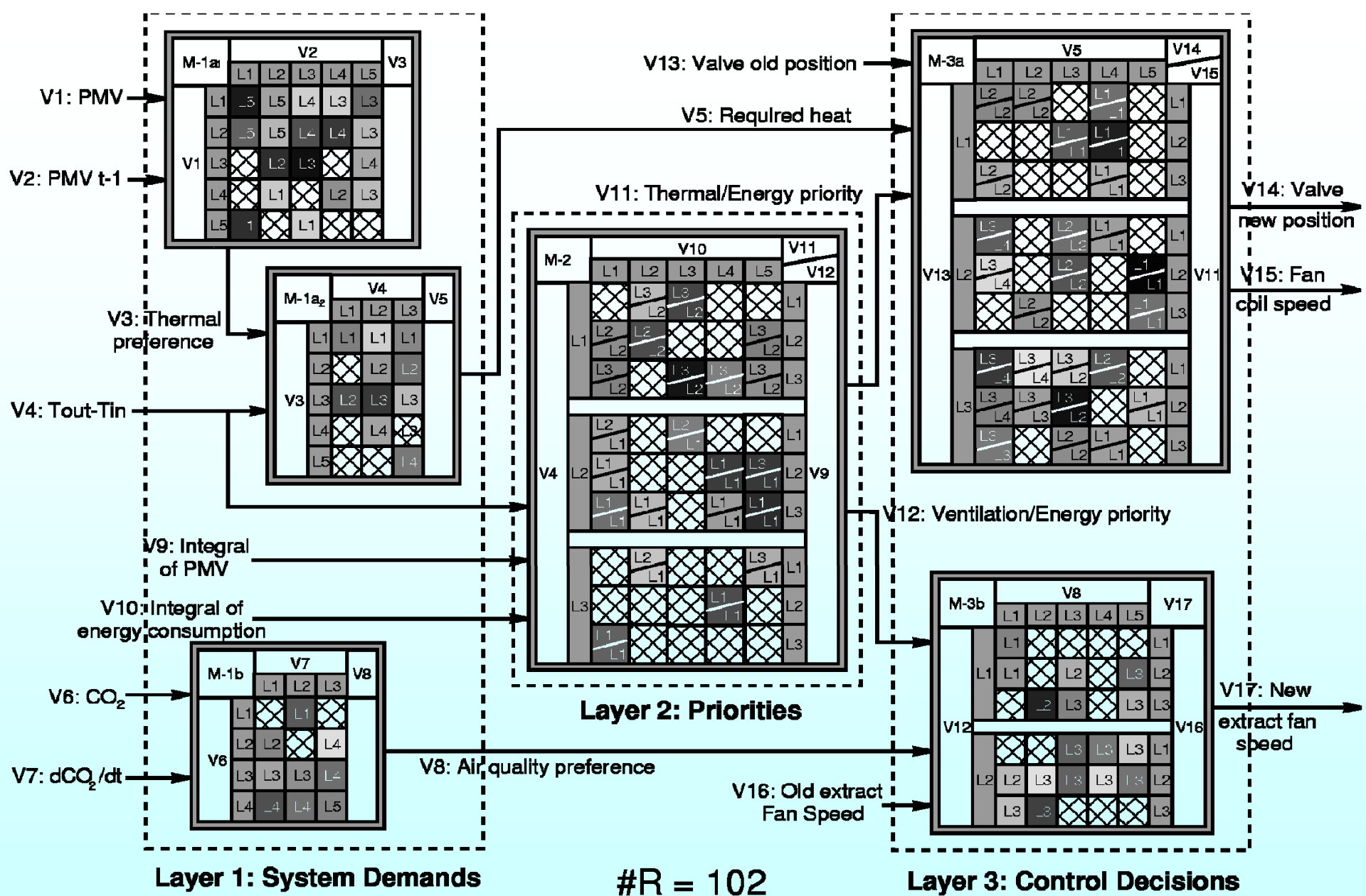

Module 1a<sub>1</sub>: Thermal Demands  
 Module 1a<sub>2</sub>: Thermal Preference  
 Module 1b: Air Quality Demands

Module 2: Energy Priorities  
 Module 3a: Required HVAC System Status  
 Module 3b: Required Ventilation System Status

# 6. Advanced GFS approaches

## OUTLINE

1. Introduction to GFSs
2. GFSs roadmap and milestones
3. Evolutionary tuning of FRBSs
4. Classical GFS learning approaches
5. Some real-world applications
6. **Advanced GFS approaches**
7. Conclusions. What's next?

## Joint coevolutionary double consequent fuzzy rule weight derivation- selection process:

R. Alcalá, J. Casillas, O. Cordón, F. Herrera, Linguistic modeling with weighted double-consequent fuzzy rules based on cooperative coevolutionary learning. *Integrated Computer Aided Engineering* 10 (4) (2003) 343-355

Cooperative coevolutionary GA with two species:

- $S_1$  (rule selection): binary chromosome of length  $m$  (# of rules derived in a first learning stage). Double-consequent rules are reduced to simple rules  
Two-point crossover and flip mutation
- $S_2$  (weight derivation): real-coded chromosome of length  $m$ . Each gene encodes the weight ( $[0,1]$ ) for the corresponding rule  
Max-min-arithmetical crossover and random mutation

# 6. Advanced GFS approaches

## OUTLINE

1. Introduction to GFSs
2. GFSs roadmap and milestones
3. Evolutionary tuning of FRBSs
4. Classical GFS learning approaches
5. Some real-world applications
- 6. Advanced GFS approaches**
7. Conclusions. What's next?

## Experimental study for the low voltage power line problem:

Method	Description
WM	Ad hoc data-driven method
ALM	The ALM double-consequent fuzzy rule method
WRL	The WRL weighted fuzzy rule method
WALM	A simple GA that learns weighted double-consequent fuzzy rules as a first approximation to the problem
WALM-CC	The proposed cooperative coevolutionary GA to learn weighted double-consequent fuzzy rules

# 6. Advanced GFS approaches

## OUTLINE

1. Introduction to GFSs
2. GFSs roadmap and milestones
3. Evolutionary tuning of FRBSs
4. Classical GFS learning approaches
5. Some real-world applications
- 6. Advanced GFS approaches**
7. Conclusions. What's next?

**Obtained results for the low voltage power line problem:**

Method	#R	MSE <sub>tra</sub>	MSE <sub>tst</sub>
WM	24	222,654	239,962
ALM	20	155,866	178,601
WRL	24	149,303	182,249
WALM	26	151,359	182,997
WALM-CC	22	144,290	176,057
NN 2-25-1	102 par.	169,399	167,092

# 6. Advanced GFS approaches





## OUTLINE

1. Introduction to GFSs
2. GFSs roadmap and milestones
3. Evolutionary tuning of FRBSs
4. Classical GFS learning approaches
5. Some real-world applications
6. **Advanced GFS approaches**
7. Conclusions. What's next?

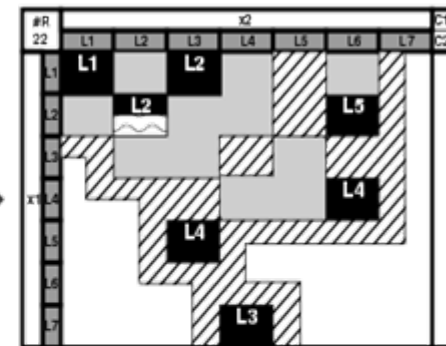
## Obtained fuzzy model:

#R	x2							C1
	L1	L2	L3	L4	L5	L6	L7	C2
x1	L1	L1 - 0.8	L2 - 0.4	L2 - 0.7			L2 - 0.1	
	L2	L1 - 0.6	L2 - 0.9	L2 - 0.5	L5 - 0.3		L5 - 0.2	
	L3		L3 - 0.1	L4 - 0.5	L3 - 0.2			
	L4		L2 - 0.3	L4 - 0.2		L3 - 0.1		
	L5				L6 - 0.2	L7 - 0.2	L4 - 1.0	
	L6			L4 - 0.1				
	L7				L3 - 0.1			



-  Significant rules
-  Cooperative rules
-  Complementary rules
-  Indirectly covered region



# 6. Advanced GFS approaches

## OUTLINE

1. Introduction to GFSs
2. GFSs roadmap and milestones
3. Evolutionary tuning of FRBSs
4. Classical GFS learning approaches
5. Some real-world applications
- 6. Advanced GFS approaches**
7. Conclusions. What's next?

## References:

- O. Cordón, F. Herrera, A proposal for improving the accuracy of linguistic modeling, IEEE TFS 8 (3) (2000) 335-344
- J. Casillas, O. Cordón, F. Herrera, COR: A methodology to improve ad hoc data-driven linguistic rule learning methods by inducing cooperation among rules. IEEE TSMC. Part B: Cybernetics 32 (4) (2002) 526-537
- O. Cordón, F. Herrera, I. Zwir, Linguistic modeling by hierarchical systems of linguistic rules, IEEE TFS 10 (1) (2002) 2-20
- R. Alcalá, J.R. Cano, O. Cordón, F. Herrera, P. Villar, I. Zwir, Linguistic Modeling with Hierarchical Systems of Weighted Linguistic Rules, IJAR 32 (2-3) (2003) 187-215

# 6. Advanced GFS approaches

## OUTLINE

1. Introduction to GFSs
2. GFSs roadmap and milestones
3. Evolutionary tuning of FRBSs
4. Classical GFS learning approaches
5. Some real-world applications
- 6. Advanced GFS approaches**
7. Conclusions. What's next?

## Genetic tuning of DB and RB using linguistic hedges:

J. Casillas, O. Cordón, M.J. del Jesus, F. Herrera, Genetic tuning of fuzzy rule deep structures preserving interpretability and its interaction with fuzzy rule set reduction, IEEE TFS 13 (1) (2005) 13-29

Genetic tuning process that refines a preliminary KB working at two different levels:

- **DB level:** Linearly or non-linearly adjusting the membership function shapes
- **RB level:** Extending the fuzzy rule structure using automatically learnt linguistic hedges

# 6. Advanced GFS approaches

## OUTLINE

1. Introduction to GFSs
2. GFSs roadmap and milestones
3. Evolutionary tuning of FRBSs
4. Classical GFS learning approaches
5. Some real-world applications
6. **Advanced GFS approaches**
7. Conclusions. What's next?

- Tuning of the DB:

### Linear tuning

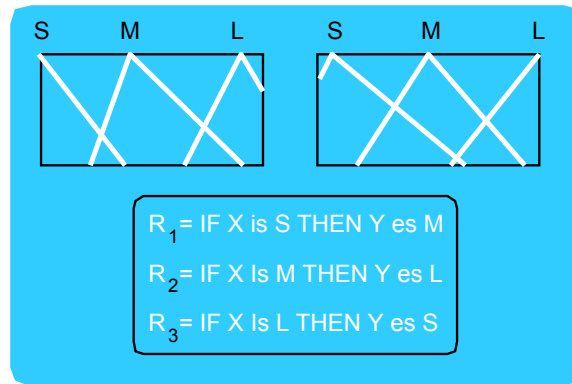

### Non-linear tuning

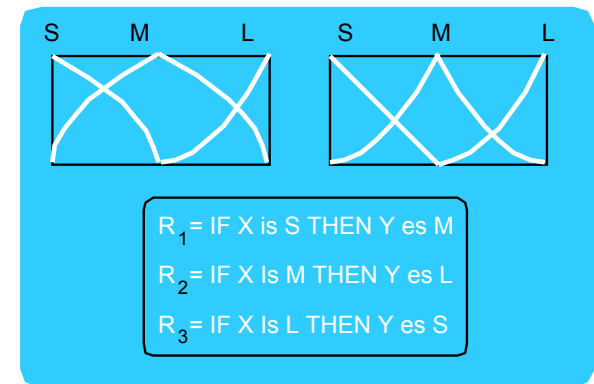

- Tuning of the RB: **linguistic hedges 'very' and 'more-or-less'**

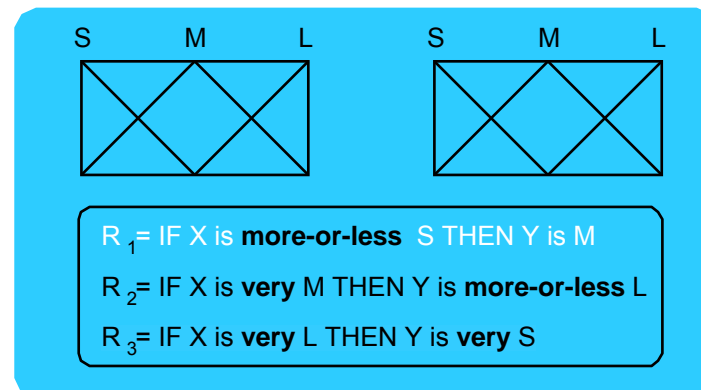

# 6. Advanced GFS approaches

## OUTLINE

1. Introduction to GFSs
2. GFSs roadmap and milestones
3. Evolutionary tuning of FRBSs
4. Classical GFS learning approaches
5. Some real-world applications
6. **Advanced GFS approaches**
7. Conclusions. What's next?

Triple coding scheme:

- Membership function parameters (**P**) (DB linear tuning): **real coding**
- Alpha values (**A**) (DB non linear tuning): **real coding**
- Linguistic hedges (**L**) (RB tuning): **integer coding**

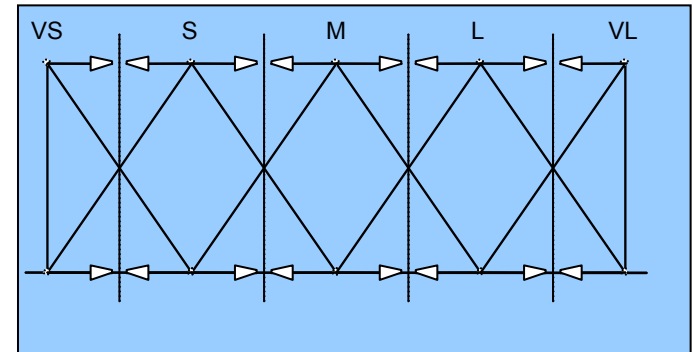

$$\alpha = \begin{cases} 1 + c_{ij}^A, & \text{si } c_{ij}^A \in [-1,0] \\ 1 + 4 \cdot c_{ij}^A, & \text{si } c_{ij}^A \in ]0,1] \end{cases}$$

$c_{ij} = 0$	$\leftrightarrow$	'very'
$c_{ij} = 1$	$\leftrightarrow$	no hedge
$c_{ij} = 2$	$\leftrightarrow$	'more-or-less'

# 6. Advanced GFS approaches

## OUTLINE

1. Introduction to GFSs
2. GFSs roadmap and milestones
3. Evolutionary tuning of FRBSs
4. Classical GFS learning approaches
5. Some real-world applications
6. **Advanced GFS approaches**
7. Conclusions. What's next?

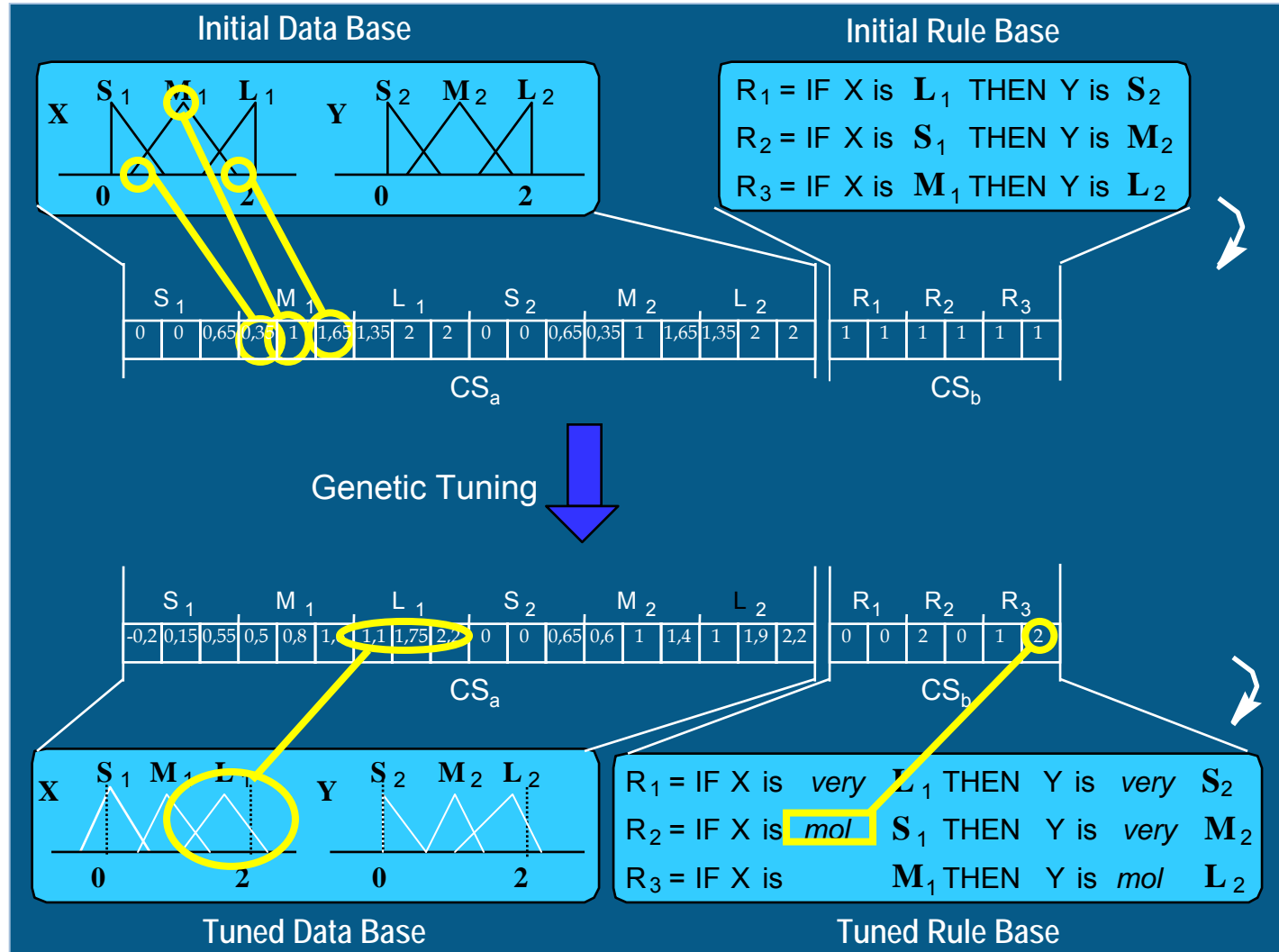

# 6. Advanced GFS approaches

## OUTLINE

1. Introduction to GFSs
2. GFSs roadmap and milestones
3. Evolutionary tuning of FRBSs
4. Classical GFS learning approaches
5. Some real-world applications
6. **Advanced GFS approaches**
7. Conclusions. What's next?

## Experimental study for the medium voltage line problem:

- Learning method considered: Wang-Mendel
- Tuning method variants:

TUNING PROCESSES CONSIDERED IN THIS EXPERIMENTAL STUDY

Method	Basic m.f. parameters	$\alpha$ m.f. parameter	Surface structure with linguistic hedges
P-tun	✓		
A-tun		✓	
L-tun			✓
PA-tun	✓	✓	
PL-tun	✓		✓
AL-tun		✓	✓
PAL-tun	✓	✓	✓

- Evaluation methodology: 5 random training-test partitions 80-20% (5-fold cross validation)  $\times$  6 runs = 30 runs per algorithm

# 6. Advanced GFS approaches

## OUTLINE

1. Introduction to GFSs
2. GFSs roadmap and milestones
3. Evolutionary tuning of FRBSs
4. Classical GFS learning approaches
5. Some real-world applications
6. **Advanced GFS approaches**
7. Conclusions. What's next?

Obtained results for the medium voltage line problem:

Tuning methods:

Method	Electrical Problem									
	$\bar{x}$				$\sigma_{\bar{x}_i}$			$\sigma_{x_i}$		
	#R	MSE <sub>tra</sub>	MSE <sub>tst</sub>	h:m:s	#R	MSE <sub>tra</sub>	MSE <sub>tst</sub>	#R	MSE <sub>tra</sub>	MSE <sub>tst</sub>
WM	65	56,135	56,359	0:00:00	0.0	1,498	4,685	—	—	—
WM+P-tun	65	18,395	22,136	<b>0:22:41</b>	0.0	778	3,200	—	1,110	1,988
WM+A-tun	65	37,243	38,837	0:33:58	0.0	455	1,816	—	<b>125</b>	<b>572</b>
WM+L-tun	65	20,967	23,420	0:25:16	0.0	632	3,207	—	336	1,439
WM+PA-tun	65	17,967	21,377	0:38:02	0.0	1,078	1,625	—	2,133	2,628
WM+PL-tun	65	<b>9,617</b>	<b>13,519</b>	0:25:33	0.0	<b>263</b>	3,153	—	694	1,509
WM+AL-tun	65	20,544	23,207	0:34:55	0.0	834	2,701	—	797	1,430
WM+PAL-tun	65	11,222	14,741	0:38:12	0.0	380	<b>1,315</b>	—	801	2,136

Other fuzzy modeling techniques and GFS:

Method	Electrical Problem									
	$\bar{x}$				$\sigma_{\bar{x}_i}$			$\sigma_{x_i}$		
	#R	MSE <sub>tra</sub>	MSE <sub>tst</sub>	h:m:s	#R	MSE <sub>tra</sub>	MSE <sub>tst</sub>	#R	MSE <sub>tra</sub>	MSE <sub>tst</sub>
Nozaki [5]	<b>532</b>	<b>26,705</b>	<b>27,710</b>	<b>0:00:00</b>	<b>0.0</b>	<b>764</b>	<b>2,906</b>	—	—	—
Thrift [38]	565.3	31,228	37,579	3:13:25	2.6	1,018	7,279	6.1	<b>2,110</b>	<b>3,609</b>
Liska [45]	624.9	49,263	56,089	7:13:34	0.1	2,356	4,628	<b>0.1</b>	7,522	11,191

# 6. Advanced GFS approaches

## OUTLINE

1. Introduction to GFSs
2. GFSs roadmap and milestones
3. Evolutionary tuning of FRBSs
4. Classical GFS learning approaches
5. Some real-world applications
6. **Advanced GFS approaches**
7. Conclusions. What's next?

**Obtained results for the medium voltage line problem:**

Example of one KB derived from the WM+PAL-tun method:

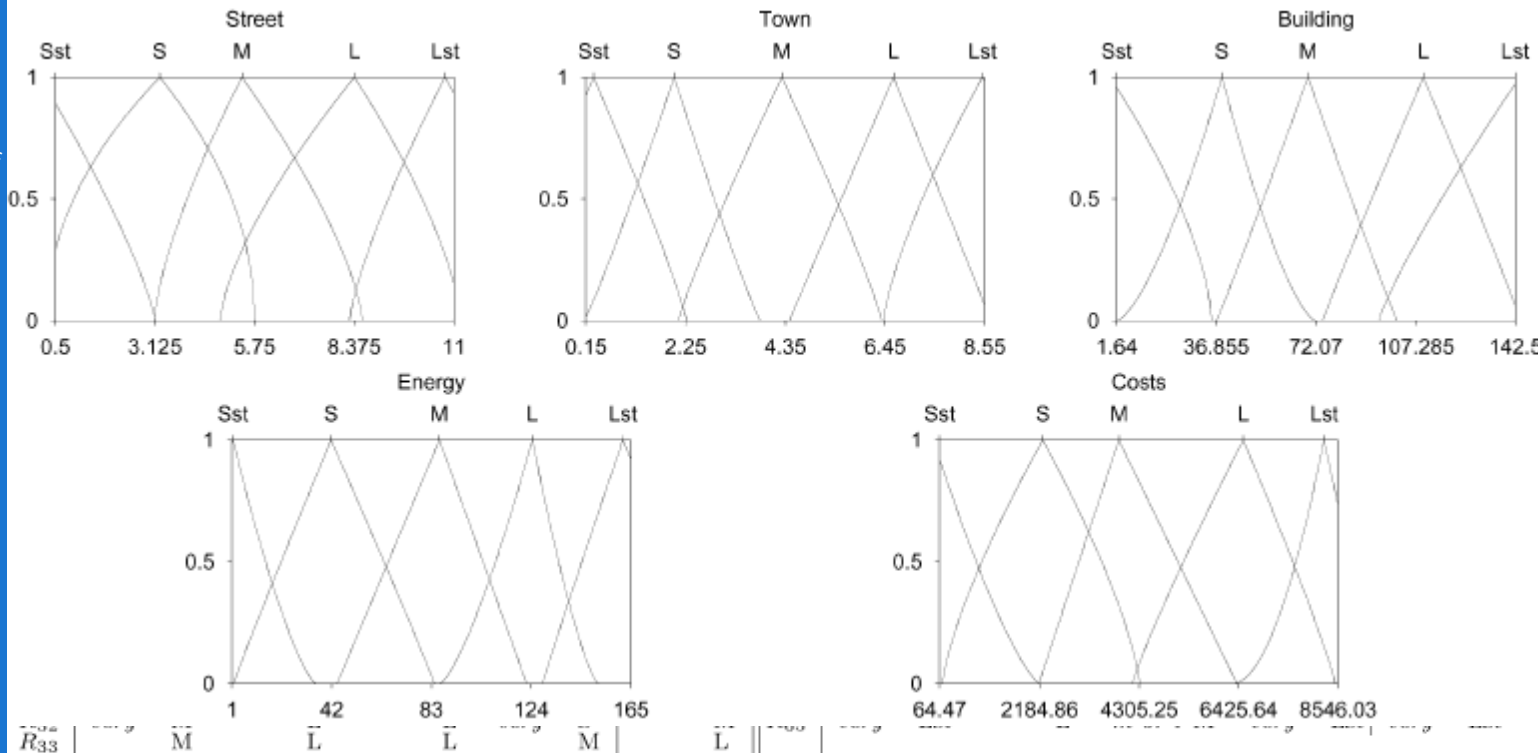

Before tuning:  $MSE_{tra/test} = 58032 / 55150$   
 After tuning:  $MSE_{tra/test} = 11395 / 14465$



# 7. Conclusions. What's next?

## OUTLINE

1. Introduction to GFSs
2. GFSs roadmap and milestones
3. Evolutionary tuning of FRBSs
4. Classical GFS learning approaches
5. Some real-world applications
6. Advanced GFS approaches
7. **Conclusions. What's next?**

- **GFSs statistics**
- **Critical view of GFSs**
- **What's next?**

# 7. Conclusions. What's next?

## OUTLINE

1. Introduction to GFSs
2. GFSs roadmap and milestones
3. Evolutionary tuning of FRBSs
4. Classical GFS learning approaches
5. Some real-world applications
6. Advanced GFS approaches
- 7. Conclusions. What's next?**

## Number of papers on GFSs published in JCR journals:

Published Items in Each Year

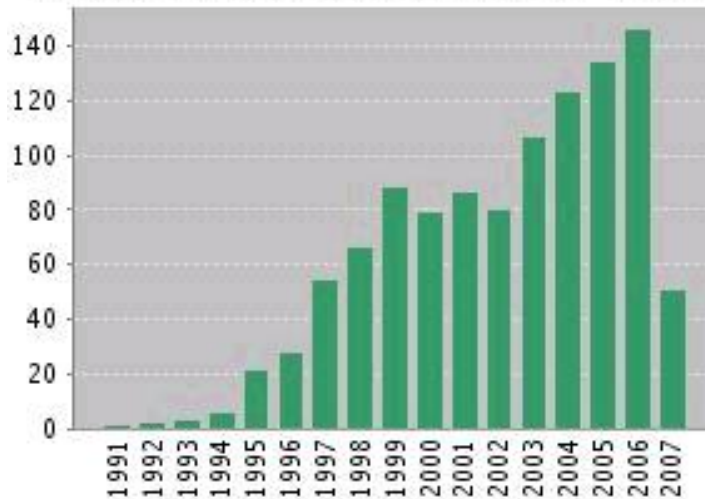

Citations in Each Year

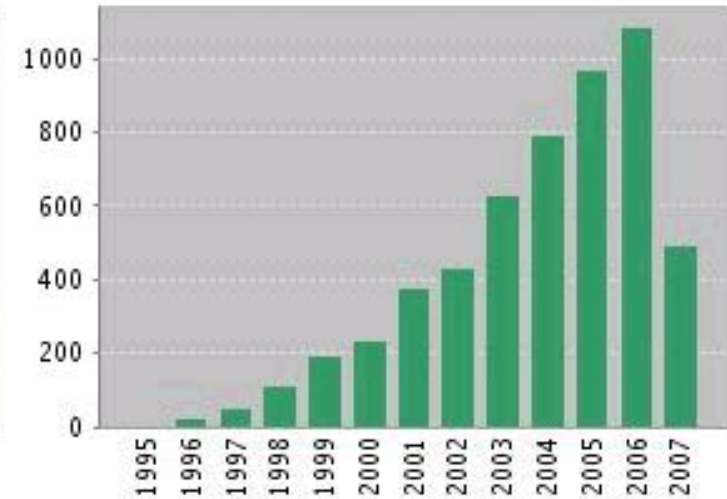

**Source:** The Thomson Corporation ISI Web of Knowledge

**Query:** (evolutionary OR "genetic algorithm\*" OR "genetic programming" OR "evolution strate\*") AND ("fuzzy rule\*" OR "fuzzy system\*" OR "fuzzy neural" OR "neuro-fuzzy" OR "fuzzy control\*" OR "fuzzy logic control\*" OR "fuzzy classific\*")

**Date:** July, 5, 2007

**Number of papers:** 1080

**Number of citations:** 5403

**Average citations per paper:** 5.0

# 7. Conclusions. What's next?

## OUTLINE

1. Introduction to GFSS
2. GFSS roadmap and milestones
3. Evolutionary tuning of FRBSs
4. Classical GFS learning approaches
5. Some real-world applications
6. Advanced GFS approaches
- 7. Conclusions. What's next?**

## Most cited papers on GFSSs:

1. Homaifar, A., McCormick, E., Simultaneous Design of Membership Functions and rule sets for fuzzy controllers using genetic algorithms, IEEE TFS 3 (2) (1995) 129-139. **Citations: 161**
2. Ishibuchi, H., Nozaki, K., Yamamoto, N., Tanaka, H., Selecting fuzzy if-then rules for classification problems using genetic algorithms, IEEE TFS 3 (3) (1995) 260-270. **Citations: 151**
3. Setnes, M., Roubos, H., GA-fuzzy modeling and classification: complexity and performance, IEEE TFS 8 (5) (2000) 509-522. **Citations: 86**
4. Park, D., Kandel, A., Langholz, G., Genetic-based new fuzzy reasoning models with application to fuzzy control, IEEE TSMC B 24 (1) (1994) 39-47. **Citations: 82**
5. Ishibuchi, H., Nakashima, T., Murata, T., Performance evaluation of fuzzy classifier systems for multidimensional pattern classification problems, IEEE TSMC B 29 (5) (1999) 601-618. **Citations: 79**
6. Herrera, F., Lozano, M., Verdegay, J.L., Tuning fuzzy-logic controllers by genetic algorithms, IJAR 12 (3-4) (1995) 299-315. **Citations: 64**
7. Shi, Y.H., Eberhart, R., Chen, Y.B., Implementation of evolutionary fuzzy systems, IEEE TFS 7 (2) (1999) 109-119. **Citations: 57**
8. Carse B., Fogarty, T.C., Munro, A., Evolving fuzzy rule based controllers using genetic algorithms, FSS 80 (3) (1996) 273-293. **Citations: 54**
9. Linkens, D.A., Nyongesa, H.O., Genetic algorithms for fuzzy control. 1. Offline system-development and application. IEE PROCEEDINGS-CONTROL THEORY AND APPLICATIONS 142 (3) (1995) 161-176. **Citations: 51**
10. Cordon, O., Herrera, F., A three-stage evolutionary process for learning descriptive and approximate fuzzy-logic-controller knowledge bases from examples, IJAR 17 (4) (1997) 369-407. **Citations: 50**

**Date:** July, 5, 2007

# 7. Conclusions. What's next?

## OUTLINE

1. Introduction to GFSs
2. GFSs roadmap and milestones
3. Evolutionary tuning of FRBSs
4. Classical GFS learning approaches
5. Some real-world applications
6. Advanced GFS approaches
- 7. Conclusions. What's next?**

## Authors with the largest publication record on GFSs:

Order	Author	Record count	% of 1080	GFS h index
1	Oh, S.K.	36	3.3333%	6
2	Herrera, F.	33	3.0556%	11
3	Pedrycz, W.	30	2.7778%	6
4	Cordón, O.	25	2.3148%	11
5	Ishibuchi, H.	18	1.6667%	8
6	Wong, C.C.	13	1.2037%	5
7	Rojas, I.	12	1.1111%	4
8	Ahn, T.C.	11	1.0185%	1
8	Hoffmann, F.	11	1.0185%	6
8	Linkens, D.A.	11	1.0185%	5
8	Pratihari, D.K.	11	1.0185%	3

**Date:** July, 5, 2007

# 7. Conclusions. What's next?

## OUTLINE

1. Introduction to GFSs
2. GFSs roadmap and milestones
3. Evolutionary tuning of FRBSs
4. Classical GFS learning approaches
5. Some real-world applications
6. Advanced GFS approaches
7. **Conclusions. What's next?**

## Critical view of GFSs:

### What is the actual GFS competence?

- Advantages and drawbacks with respect to other Computational Intelligence techniques
- Capability to solve real-world problems
- Visibility of GFSs outside the fuzzy community
- Impact of GFSs in a broader research community

# 7. Conclusions. What's next?

## OUTLINE

1. Introduction to GFSs
2. GFSs roadmap and milestones
3. Evolutionary tuning of FRBSs
4. Classical GFS learning approaches
5. Some real-world applications
6. Advanced GFS approaches
7. **Conclusions. What's next?**

## What are GFS researchers doing badly?

### Experimental setup:

- Extended use of toy problems in journal papers
- Just one (or at most a few) algorithm run. No statistical test use for the performance checking
- "Soft comparison" against other classical and Computational Intelligence tools for the problem tackled
- Need of benchmark problem databases (only existing for classification applications (UCI))

# 7. Conclusions. What's next?

## OUTLINE

1. Introduction to GFSs
2. GFSs roadmap and milestones
3. Evolutionary tuning of FRBSs
4. Classical GFS learning approaches
5. Some real-world applications
6. Advanced GFS approaches
- 7. Conclusions.  
What's next?**

## What's next in GFSs:

### Forecasting:

- New learning approaches and coding schemes
- New application areas: Internet, Bioinformatics, ...
- More multi-objective approaches
- Increasing interest on the interpretability-accuracy trade-off
- More real-world applications
- Scaling up to high-dimensional problems

# 7. Conclusions. What's next?

## OUTLINE

1. Introduction to GFSs
2. GFSs roadmap and milestones
3. Evolutionary tuning of FRBSs
4. Classical GFS learning approaches
5. Some real-world applications
6. Advanced GFS approaches
7. **Conclusions. What's next?**

- **New coding schemes**

- GFSs based on 2 and 3-tuple fuzzy rule representation

- **New learning schemes**

- New Michigan GFS
- New multi-objective GFS for the interpretability-accuracy trade-off

- **New kinds of problems**

- GFSs for handling inherently fuzzy data



# 7. Conclusions. What's next?

## OUTLINE

1. Introduction to GFSs
2. GFSs roadmap and milestones
3. Evolutionary tuning of FRBSs
4. Classical GFS learning approaches
5. Some real-world applications
6. Advanced GFS approaches
7. Conclusions. What's next?

## New coding schemes: 2- and 3-tuples:

**IDEA:** New fuzzy rule representation model permitting a more flexible definition of the fuzzy sets of the linguistic labels

- **2-tuples:** label id.  $i$  and a displacement parameter  $\alpha_i \in [-0.5, 0.5]$

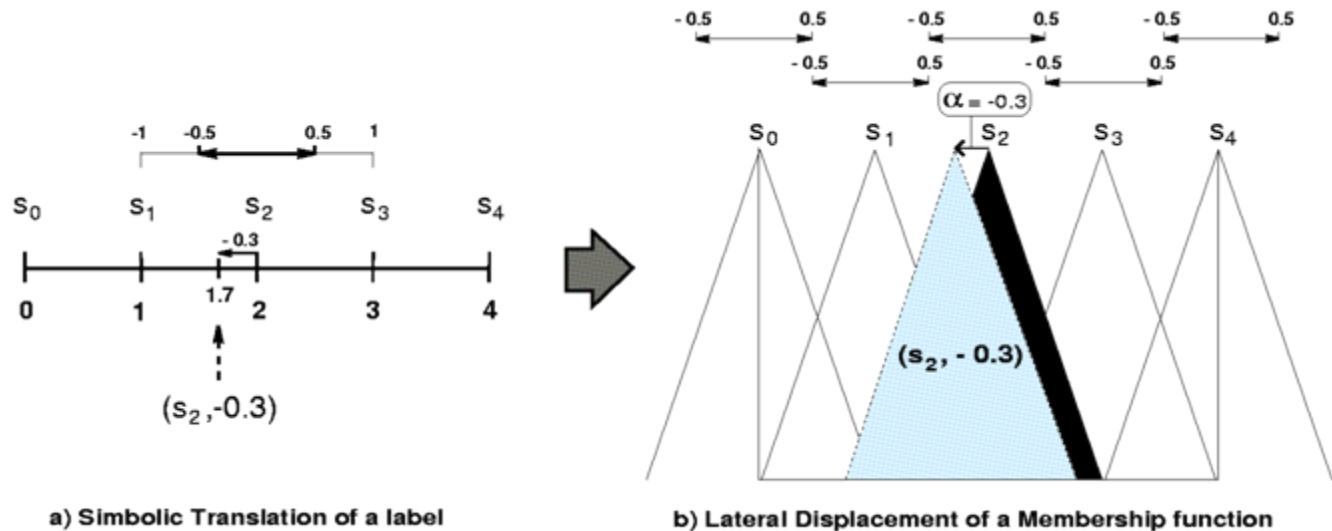

- New rule structure:

IF  $X_1$  IS  $(S^1_i, \alpha_1)$  AND ... AND  $X_n$  IS  $(S^n_i, \alpha_n)$  THEN  $Y$  IS  $(S^y_i, \alpha_y)$

# 7. Conclusions. What's next?

## OUTLINE

1. Introduction to GFSs
2. GFSs roadmap and milestones
3. Evolutionary tuning of FRBSs
4. Classical GFS learning approaches
5. Some real-world applications
6. Advanced GFS approaches
7. Conclusions. What's next?

- **3-tuples**: label id.  $i$ , a displacement parameter  $\alpha_i \in [-0.5, 0.5]$ , and a width parameter  $\beta_i \in [-0.5, 0.5]$

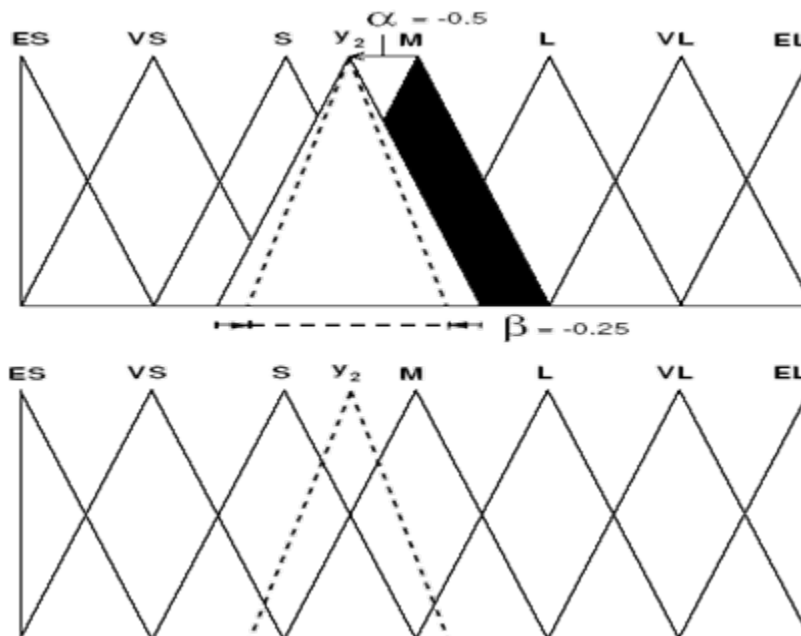

- New rule structure:  
IF  $X_1$  IS  $(S^1_i, \alpha_1, \beta_1)$  AND ... AND  $X_n$  IS  $(S^n_i, \alpha_n, \beta_n)$  THEN  $Y$  IS  $(S^{y_i}, \alpha_y, \beta_y)$

# 7. Conclusions. What's next?

## OUTLINE

1. Introduction to GFSs
2. GFSs roadmap and milestones
3. Evolutionary tuning of FRBSs
4. Classical GFS learning approaches
5. Some real-world applications
6. Advanced GFS approaches
- 7. Conclusions. What's next?**

## New coding schemes: 2- and 3-tuples:

**COLLATERAL PRO:** Both structures decreases the KB learning/tuning complexity, since the fuzzy sets are encoded using a lower number of parameters

## Existing proposals:

- Genetic 2-tuple/3-tuple DB global tuning: adjustment of the global fuzzy sets → **full interpretability** (usual fuzzy partitions)
- Genetic 2-tuple/3-tuple DB tuning at rule level → **lower interpretability, higher flexibility** (like scatter Mamdani FRBSs)
- Genetic 2-tuple/3-tuple DB tuning + rule selection
- KB derivation through a priori genetic 2-tuple/3-tuple DB learning: granularity and 2-tuple/3-tuple parameter learning → **full interpretability** (usual fuzzy partitions)

# 7. Conclusions. What's next?

## OUTLINE

1. Introduction to GFSs
2. GFSs roadmap and milestones
3. Evolutionary tuning of FRBSs
4. Classical GFS learning approaches
5. Some real-world applications
6. Advanced GFS approaches
7. **Conclusions. What's next?**

## Obtained results for the medium voltage line problem:

Genetic 2-tuple tuning + rule selection method:

Method	#R	MSE <sub>tra</sub>	$\sigma_{tra}$	t-test	MSE <sub>tst</sub>	$\sigma_{tst}$	t-test
Approaches without tuning							
WM	12.4	234712	32073	+	242147	24473	+
S	10.0	226135	19875	+	241883	19410	+
Approaches with global semantics							
T	12.4	158662	6495	+	221613	29986	+
T+S	8.9	156313	2967	+	193477	49912	=
GL <sub>dd</sub>	12.4	166674	11480	+	189216	14743	=
GL <sub>dd</sub> +S	9.0	160081	7316	+	189844	22448	=
Approaches with local semantics							
PAL	12.4	141638	4340	+	189279	19523	=
PAL+S	10.6	145712	5444	+	191922	16987	=
LL <sub>dd</sub>	12.4	139189	3155	*	191604	18243	=
LL <sub>dd</sub> +S	10.5	141446	3444	=	186746	15762	*

- 5-fold cross validation  $\times$  6 runs = 30 runs per algorithm
- T-student test with 95% confidence

# 7. Conclusions. What's next?

## OUTLINE

1. Introduction to GFSs
2. GFSs roadmap and milestones
3. Evolutionary tuning of FRBSs
4. Classical GFS learning approaches
5. Some real-world applications
6. Advanced GFS approaches
7. **Conclusions. What's next?**

**Obtained results for the medium voltage line problem:**

Example of one KB derived from the global tuning method:

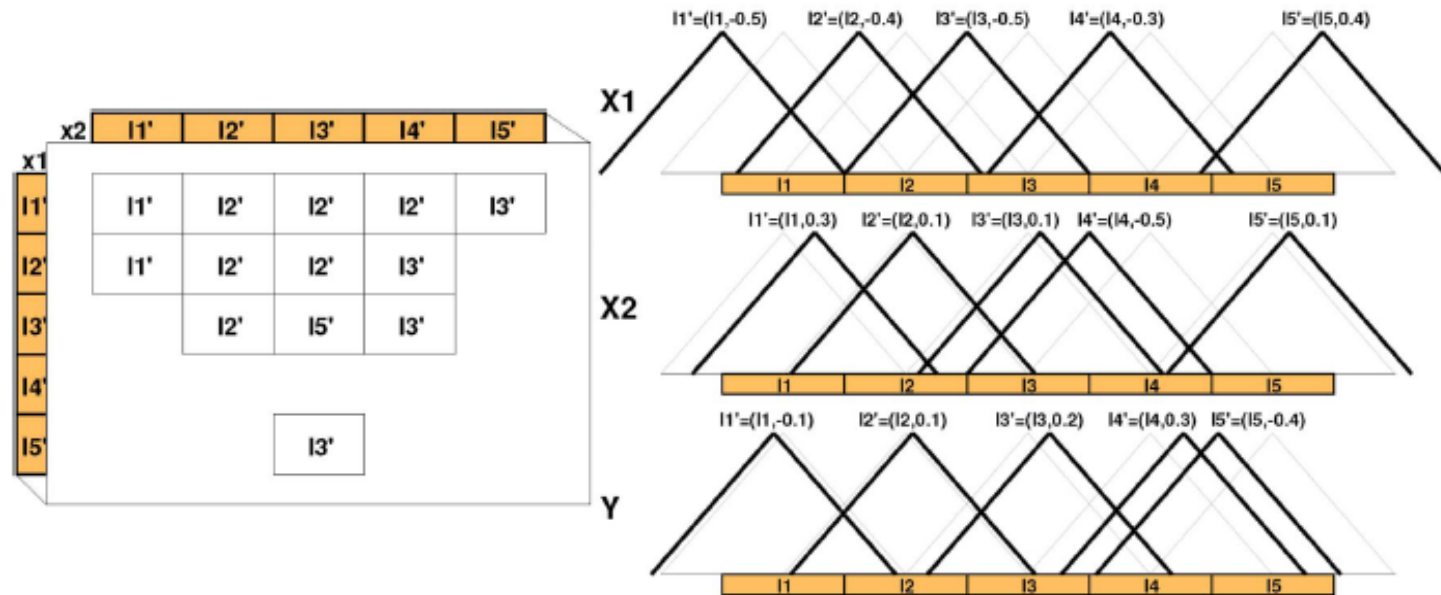

After tuning+rule selection:  $\#R=13$ ;  $MSE_{tra/test} = 187494 / 176581$

# 7. C



## OUTLINE

1. Introduction to GFSs
2. GFSs roadmap and milestones
3. Evolutionary tuning of FRBSs
4. Classical GFS learning approaches
5. Some real-world applications
6. Advanced GFS approaches
7. Conclusions. What's next?

MODEL	#R	PMV		CO <sub>2</sub>	Energy		Stability		
		O <sub>1</sub>	O <sub>2</sub>	O <sub>3</sub>	O <sub>4</sub>	%	O <sub>5</sub>	%	
Rule Selection									
S1	147	0.2	0	0	2867692	10.56	991	12.76	
S2	162	0.0	0	0	2889889	9.87	1441	-26.85	
S3	172	0.0	0	0	2901686	9.50	1505	-32.48	
Classic Tuning									
C1	172	0.0	0	0	2575949	19.66	1115	1.85	
C2	172	0.0	0	0	2587326	19.31	1077	5.19	
C3	172	0.0	0	0	2596875	19.01	1051	7.48	
Selection with Classic Tuning									
C+S1	94	0.0	0	0	2540065	20.78	1294	-13.91	
C+S2	109	0.1	0	0	2492462	22.27	989	12.94	
C+S3	100	0.1	0	0	2578019	19.60	887	21.92	
Global Lateral Tuning									
GL <sub>SS</sub> 1	172	0.7	0	0	2378784	25.81	1069	5.90	
GL <sub>SS</sub> 2	172	1.0	0	0	2327806	27.40	1066	6.16	
GL <sub>SS</sub> 3	172	0.9	0	0	2268689	29.25	1080	4.93	
Local Lateral Tuning									
LL <sub>SS</sub> 1	172	0.9	0	0	2386033	25.59	896	21.13	
LL <sub>SS</sub> 2	172	0.8	0	0	2343409	26.92	943	16.99	
LL <sub>SS</sub> 3	172	0.3	0	0	2377596	25.85	938	17.43	
Selection with Global Lateral Tuning									
GL <sub>SS</sub> +S1	105	1.0	0	0	2218598	30.81	710	37.50	
GL <sub>SS</sub> +S2	115	0.4	0	0	2358405	26.45	818	27.99	
GL <sub>SS</sub> +S3	118	0.8	0	0	2286976	28.68	872	23.24	
Selection with Local Lateral Tuning									
LL <sub>SS</sub> +S1	133	0.5	0	0	2311986	27.90	788	30.63	
LL <sub>SS</sub> +S2	104	0.6	0	0	2388470	25.51	595	47.62	
LL <sub>SS</sub> +S3	93	0.5	0	0	2277807	28.96	1028	9.51	

# 7. Conclusions. What's next?

## Tuned Data Base (GL-SS<sub>1</sub>):

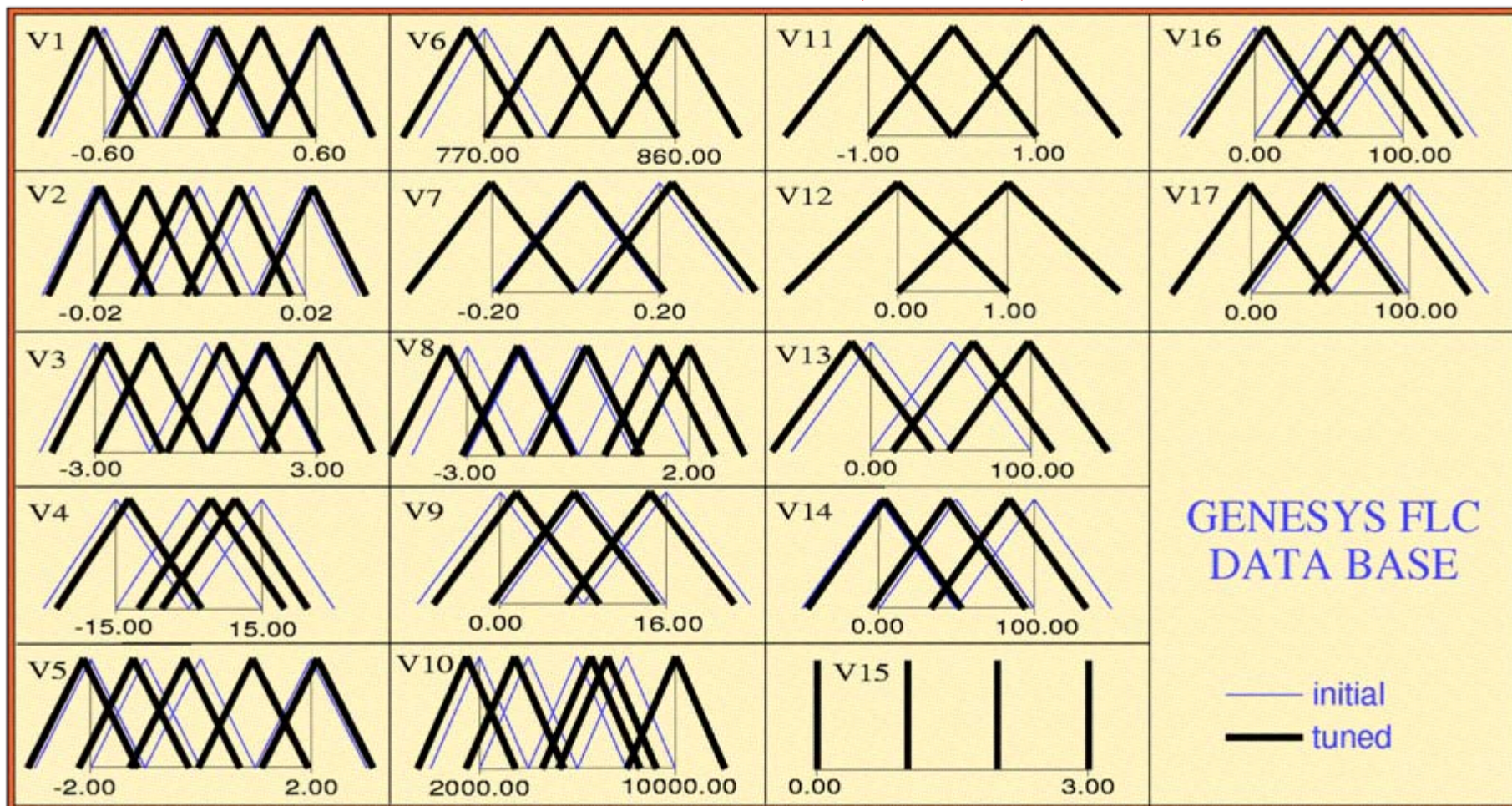

#R = 105

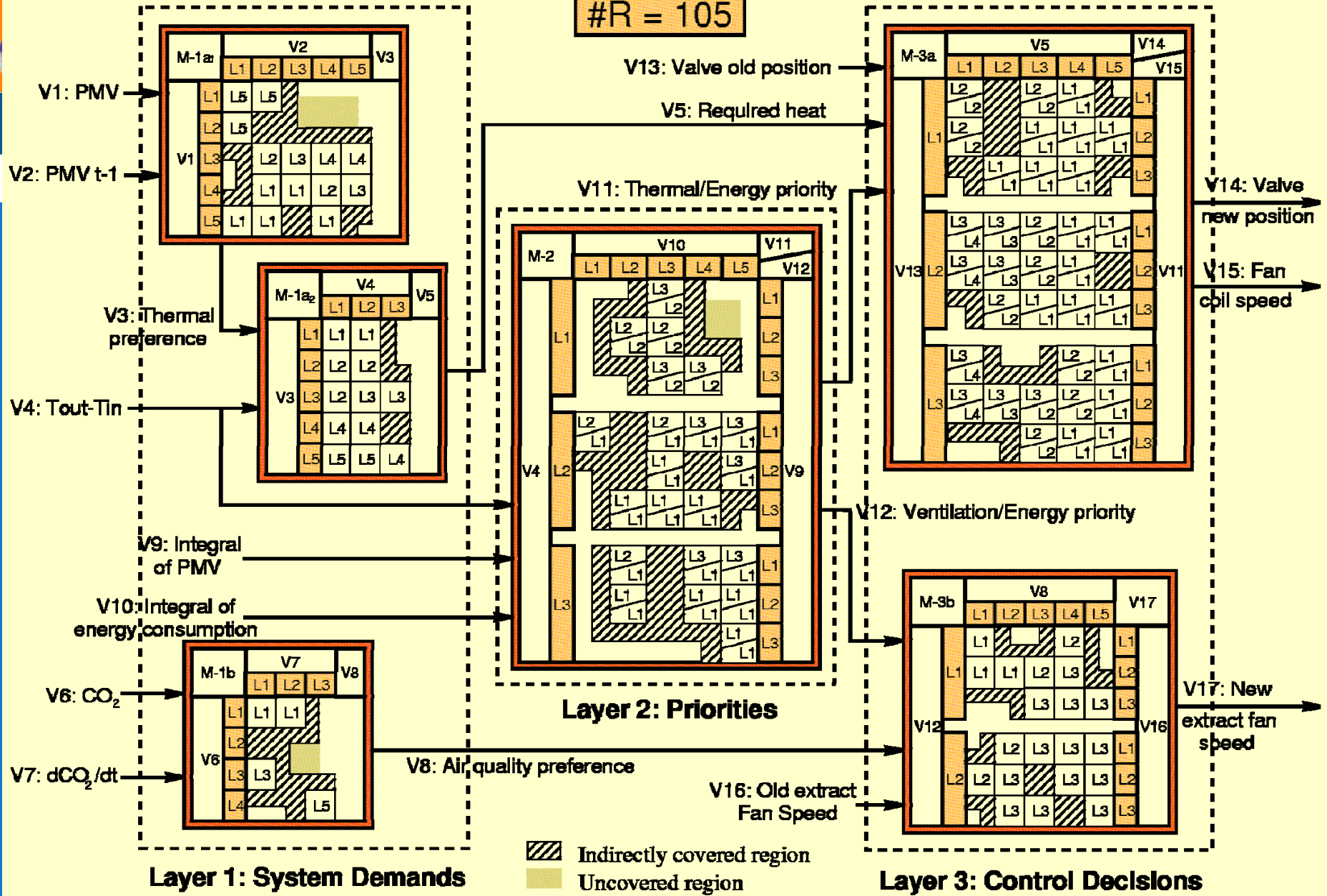

Module 1a<sub>1</sub>: Thermal Demands  
 Module 1a<sub>2</sub>: Thermal Preference  
 Module 1b: Air Quality Demands

Module 2: Energy Priorities  
 Module 3a: Required HVAC System Status  
 Module 3b: Required Ventilation System Status



# 7. Conclusions. What's next?

## OUTLINE

1. Introduction to GFSs
2. GFSs roadmap and milestones
3. Evolutionary tuning of FRBSs
4. Classical GFS learning approaches
5. Some real-world applications
6. Advanced GFS approaches
- 7. Conclusions. What's next?**

## References:

- R. Alcalá, J. Alcalá-Fdez, F. Herrera, J. Otero, Genetic learning of accurate and compact fuzzy rule based systems based on the 2-tuples linguistic representation, IJAR 44 (1) (2007) 45-64
- R. Alcalá, J. Alcalá-Fdez, M.J. Gacto, F. Herrera, Rule base reduction and genetic tuning of fuzzy systems based on the linguistic 3-tuples representation, Soft Computing 11 (5) (2007) 401-419
- R. Alcalá, J. Alcalá-Fdez, F. Herrera, A proposal for the genetic lateral tuning of linguistic fuzzy systems and its interaction with rule selection, IEEE TFS 15(4) (2007) 616-635
- R. Alcalá, J. Alcalá-Fdez, M.J. Gacto, F. Herrera, Improving fuzzy logic controllers obtained by experts: a case study in HVAC systems, Appl. Intel, in press

# 7. Conclusions. What's next?

## OUTLINE

1. Introduction to GFSs
2. GFSs roadmap and milestones
3. Evolutionary tuning of FRBSs
4. Classical GFS learning approaches
5. Some real-world applications
6. Advanced GFS approaches
7. **Conclusions. What's next?**

## New learning schemes: A new Michigan GFS:

J. Casillas, B. Carse, L. Bull, Fuzzy-XCS: a michigan genetic fuzzy system. IEEE TFS, in press

- Rule generalization (compact rule-based descriptions of state-action relationships) and the interplay between general and specific rules in the same evolving population have received a great attention in non-fuzzy classifier systems (e.g., XCS research)
- but not in Michigan-style fuzzy rule systems due to the difficulty in extending the discrete-valued system operation to the continuous case
- Generalized rules allow more compact rule bases, scalability to higher dimensional spaces, faster inference, and better linguistic interpretability
- It would be a nice solution to the GFS interpretability-accuracy trade-off

**PROPOSAL: fuzzy XCS system for single-step reinforcement problems**

# 7. Conclusions. What's next?

## OUTLINE

1. Introduction to GFSs
2. GFSs roadmap and milestones
3. Evolutionary tuning of FRBSs
4. Classical GFS learning approaches
5. Some real-world applications
6. Advanced GFS approaches
7. **Conclusions. What's next?**

- Traditional evolutionary reinforcement learning algorithms are **"strength-based"**: a rule accrues strength during interaction with the environment (through rewards and/or penalties)
- A different approach is that were a rule's fitness is based on its **"accuracy"**, i.e. how well a rule predicts payoff whenever it fires
- This accuracy concept is different from the fuzzy modeling one
- Broadly speaking, the strength is the mean of the obtained payoffs and the accuracy is the corresponding standard deviation
- **Pros of the accuracy-based approach**: avoiding overgeneral rules, obtaining optimally general rules, and learning of a complete "covering map"

# 7. Conclusions. What's next?

## OUTLINE

1. Introduction to GFSs

2. GFSs roadmap and milestones

3. Evolutionary tuning of FRBSs

4. Classical GFS learning approaches

5. Some real-world applications

6. Advanced GFS approaches

7. **Conclusions.**  
**What's next?**

- XCS was the first accuracy-based EA and it is currently of major interest to the research community in this field. However, **all the proposals of Michigan-style GFSs are strength-based**
- Casillas et al. propose an accuracy-based Michigan-style GFS, Fuzzy-XCS, based on XCS but properly adapted to fuzzy systems
- The proposed system interacts with the environment by means of continuous actions
- The on-line behavior involves two cycles: action and learning
- A DNF rule representation is considered to maximize the payoff

# 7. Conclusions. What's next?

## OUTLINE

1. Introduction to GFSs
2. GFSs roadmap and milestones
3. Evolutionary tuning of FRBSs
4. Classical GFS learning approaches
5. Some real-world applications
6. Advanced GFS approaches
7. Conclusions. What's next?

## Accuracy-based Fuzzy XCS structure:

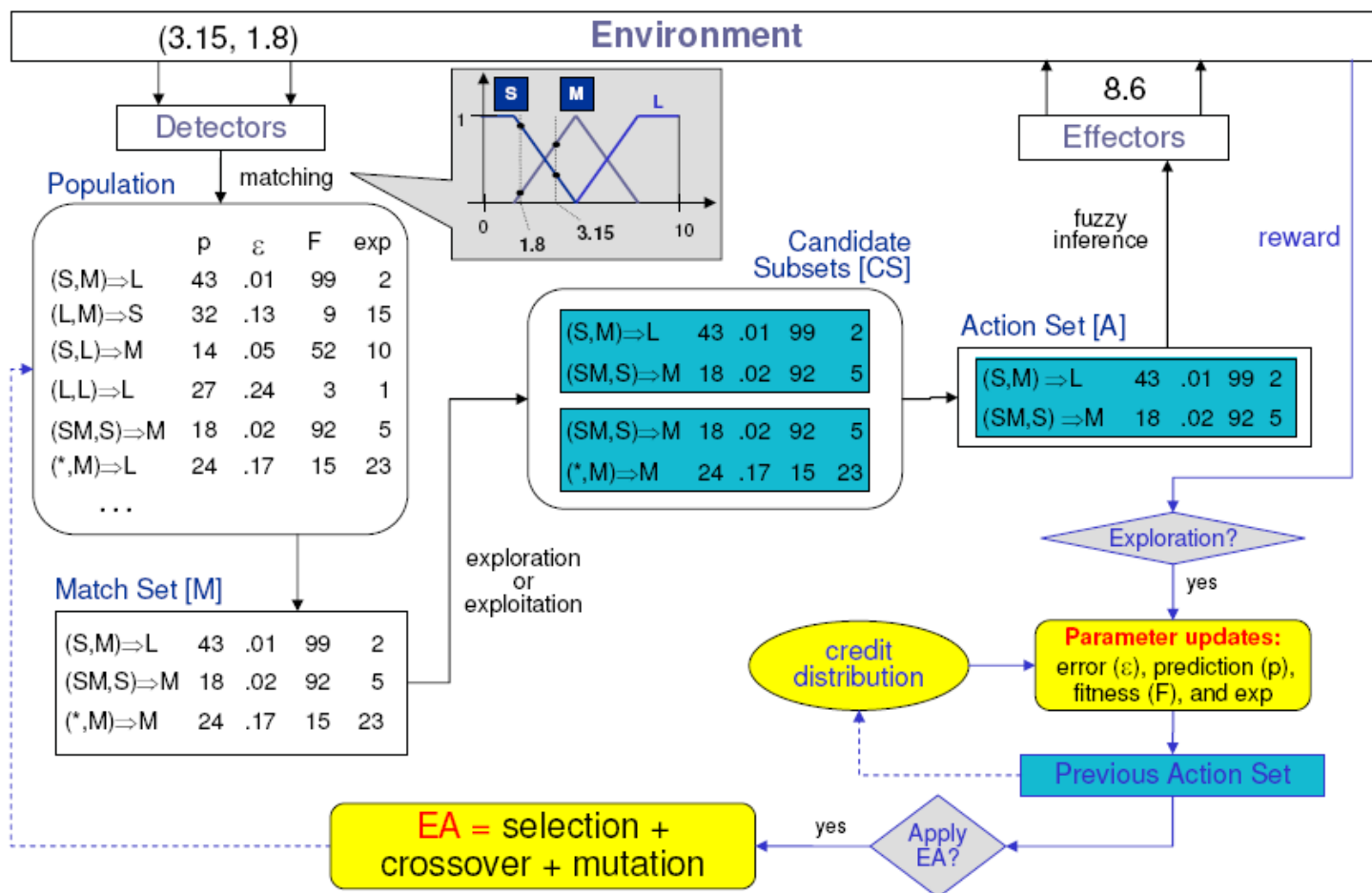

# 7. Conclusions. What's next?

## OUTLINE

1. Introduction to GFSs
2. GFSs roadmap and milestones
3. Evolutionary tuning of FRBSs
4. Classical GFS learning approaches
5. Some real-world applications
6. Advanced GFS approaches
- 7. Conclusions. What's next?**

## New learning schemes: New multi-objective GFS for the interpretability-accuracy trade-off:

R. Alcalá, J. Alcalá-Fdez, M.J. Gacto, F. Herrera, A multi-objective genetic algorithm for tuning and rule selection to obtain accurate and compact linguistic fuzzy rule-based systems, *IJUFKBS*, 15(5) (2007) 539-557

- Multi-objective EAs are powerful tools to generate GFSs but they are based on getting a large, well distributed and spread off, Pareto set of solutions
- The two criteria to optimize in GFSs are accuracy and interpretability. The former is more important than the latter, so many solutions in the Pareto set are not useful
- Solution: Inject knowledge through the MOEA run to bias the algorithm to generate the desired Pareto front part

# 7. Conclusions. What's next?

## Pareto front classification in an interpretability-accuracy GFSs:

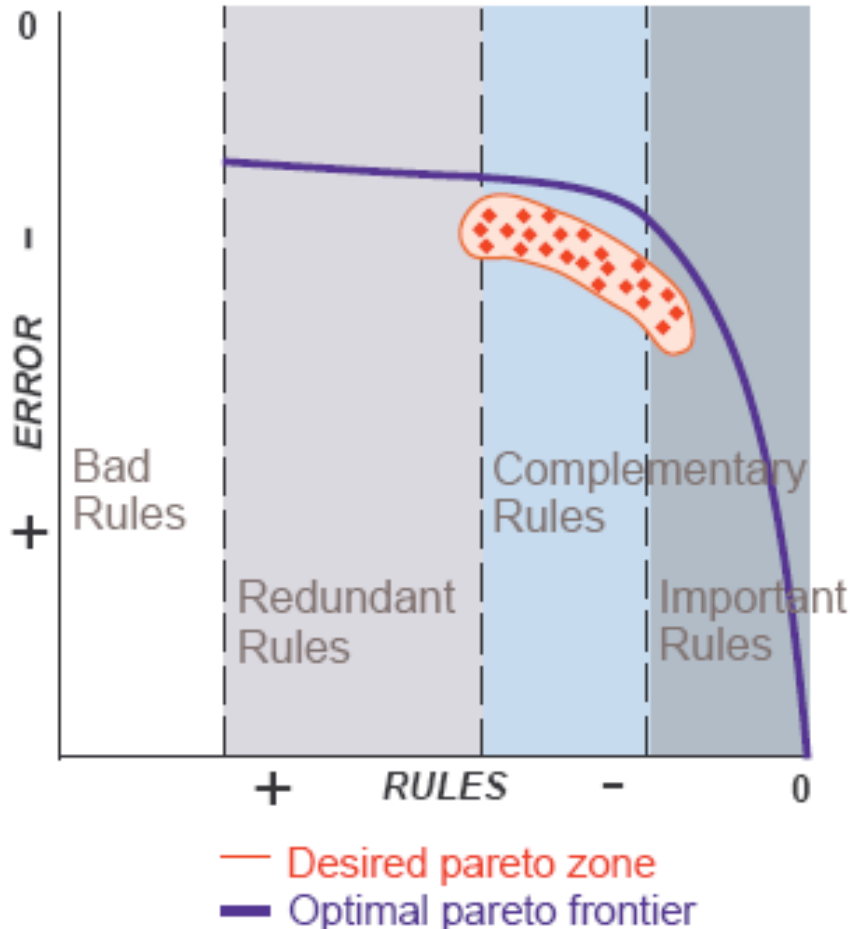

- **Bad rules zone:** solutions with bad performance rules. Removing them improves the accuracy, so no Pareto solutions are located here
- **Redundant rules zone:** solutions with irrelevant rules. Removing them does not affect the accuracy and improves the interpretability
- **Complementary rules zone:** solutions with neither bad nor irrelevant rules. Removing them slightly decreases the accuracy
- **Important rules zone:** solutions with essential rules. Removing them significantly decreases the accuracy

# 7. Conclusions. What's next?

## OUTLINE

1. Introduction to GFSs
2. GFSs roadmap and milestones
3. Evolutionary tuning of FRBSs
4. Classical GFS learning approaches
5. Some real-world applications
6. Advanced GFS approaches
7. **Conclusions. What's next?**

## Accuracy-oriented modifications performed:

- Restart the genetic population at the middle of the run time, keeping the individual with the highest accuracy as the only one in the external population and generating all the new individuals with the same number of rules it has
- In each MOGA step, the number of chromosomes in the external population considered for the binary tournament is decreased, focusing the selection on the higher accuracy individuals



# 7. Conclusions. What's next?

## OUTLINE

1. Introduction to GFSs
2. GFSs roadmap and milestones
3. Evolutionary tuning of FRBSs
4. Classical GFS learning approaches
5. Some real-world applications
6. Advanced GFS approaches
7. **Conclusions. What's next?**

## Obtained results for the medium voltage line problem:

Multi-objective genetic tuning + rule selection method:

Method	#R	MSE <sub>tra</sub>	$\sigma_{tra}$	t-test	MSE <sub>tst</sub>	$\sigma_{tst}$	t-test
WM	65	57605	2841	+	57934	4733	+
WM+T	65	18602	1211	+	22666	3386	+
WM+S	40.8	41086	1322	+	59942	4931	+
WM+TS	41.9	14987	391	+	18973	3772	+
NSGAI	41.0	14488	965	+	18419	3054	+
NSGAI <sub>ACC</sub>	48.1	16321	1636	+	20423	3138	+
SPEA2	<b>33</b>	13272	1265	+	17533	3226	+
SPEA2 <sub>ACC</sub>	34.5	<b>11081</b>	1186	*	<b>14161</b>	2191	*

- 5-fold cross validation  $\times$  6 runs = 30 runs per algorithm
- T-student test with 95% confidence

# 7. Conclusions. What's next?

Comparison of the SPEA2 – SPEA2acc convergence:

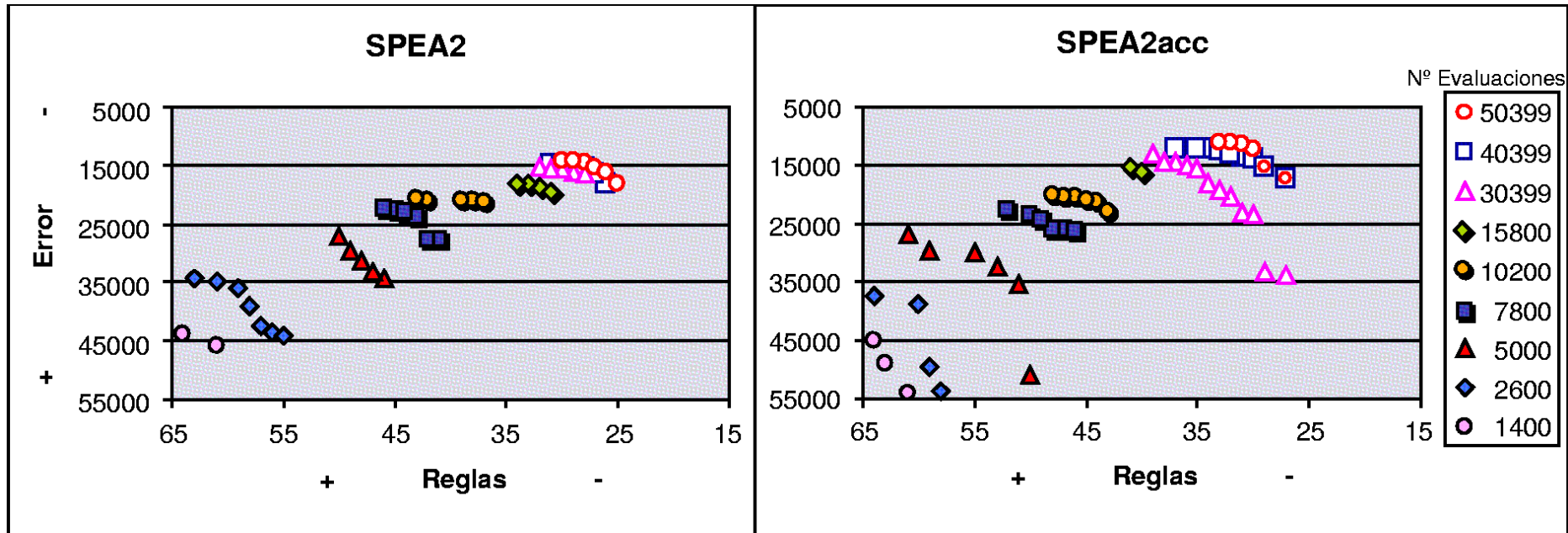

# 7. Conclusions. What's next?

## OUTLINE

1. Introduction to GFSs
2. GFSs roadmap and milestones
3. Evolutionary tuning of FRBSs
4. Classical GFS learning approaches
5. Some real-world applications
6. Advanced GFS approaches
7. **Conclusions. What's next?**

## GFSs for handling inherently fuzzy data:

- There are many practical problems requiring learning models from uncertain data:
  - Those with coarse-grained digital data, as obtained when weighing small objects in a low resolution scale, or
  - with values comprising both a numerical measure and one or more confidence intervals defining its imprecision (e.g., the position given by a GPS sensor)
- In either case, there is an unknown difference between the true measure and the observed one
- Assuming it to be stochastic noise is an oversimplification. Intervals or fuzzy sets are best suited to represent the uncertainty in the observation

# 7. Conclusions. What's next?

## OUTLINE

1. Introduction to GFSs
2. GFSs roadmap and milestones
3. Evolutionary tuning of FRBSs
4. Classical GFS learning approaches
5. Some real-world applications
6. Advanced GFS approaches
- 7. Conclusions.  
What's next?**

- Fuzzy systems have been extensively applied to learning problems dealing with crisp data, that can be also solved by many other classical (statistical) and computational intelligence techniques
- However, their intrinsic characteristics make them one of the few and most adapted tools to deal with the latter problems!
- Moreover, an interval or fuzzy-based representation can also be used to:
  - reconcile different measurements of a feature in a given object, and
  - to describe incomplete knowledge about a value (for example, a missing input value can be codified by an interval spanning the whole range of the variable)

### IDEA:

- **advocate the use of fuzzy data to learn and evaluate GFSs, and**
- **raise the use of fuzzy-valued fitness functions to formulate that kind of problems**

# 7. Conclusions. What's next?

## OUTLINE

1. Introduction to GFSs
2. GFSs roadmap and milestones
3. Evolutionary tuning of FRBSs
4. Classical GFS learning approaches
5. Some real-world applications
6. Advanced GFS approaches
7. Conclusions. What's next?

## Some examples of practical applications:

- Crisp data with hand-added fuzziness: increase of fuzzy models/classifiers robustness:

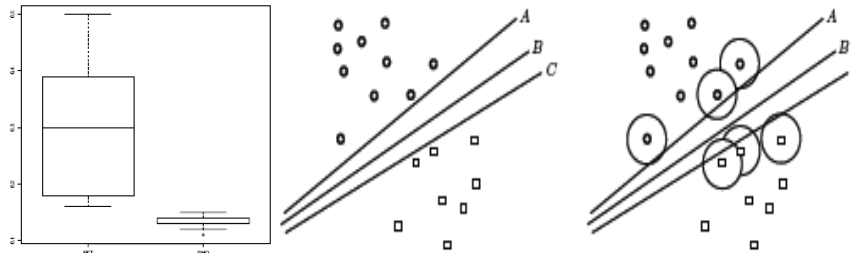

- Transformations of data based on semantic interpretations of fuzzy sets: factor evaluation of questionnaires in marketing

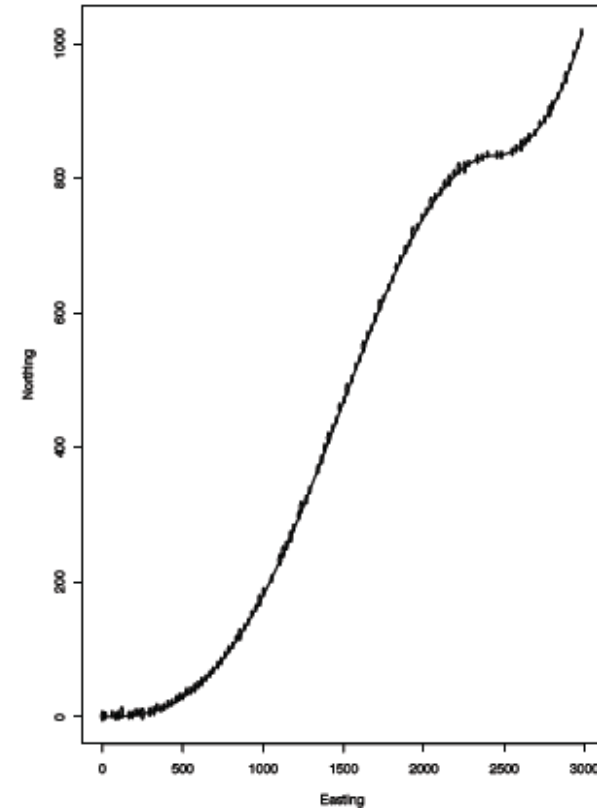
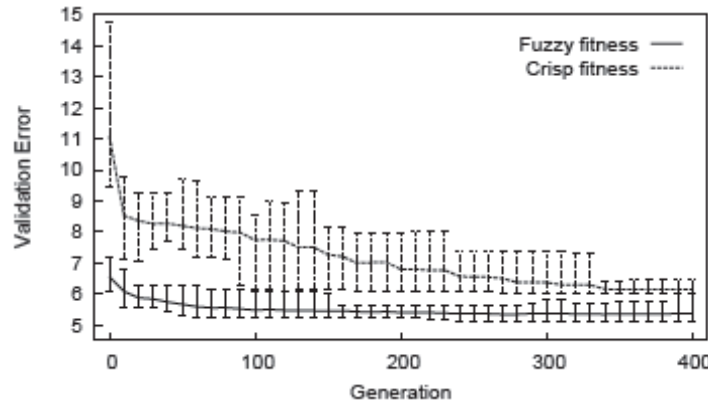

- Inherently fuzzy data: taxi meter calibration with a GPS

# 7. Conclusions. What's next?

## OUTLINE

1. Introduction to GFSS
2. GFSS roadmap and milestones
3. Evolutionary tuning of FRBSs
4. Classical GFS learning approaches
5. Some real-world applications
6. Advanced GFS approaches
- 7. Conclusions. What's next?**

## References:

- L. Sánchez, I. Couso, J. Casillas, Modeling vague data with genetic fuzzy systems under a combination of crisp and imprecise criteria, Proc. First IEEE Symp. on Comp. Intelligence in Multi-Criteria Decision-Making (MCDM 2007), Honolulu, USA, 2007
- L. Sánchez, J. Otero. Learning fuzzy linguistic models from low quality data by genetic algorithms, Proc. FUZZ-IEEE 2007, London, UK, 2007
- L. Sánchez, I. Couso, J. Casillas, A multiobjective genetic fuzzy system with imprecise probability fitness for vague data, Proc. Second Intl. Symposium on Evolving Fuzzy Systems 2006 (EFS06), Ambleside, UK, 2006, pp. 131-137
- J. Casillas, L. Sánchez, Knowledge extraction from fuzzy data for estimating consumer behavior models, Proc. FUZZ-IEEE 2006, Vancouver, 2006, pp. 572-578
- J.R. Villar, A. Otero, J. Otero, L. Sánchez, Genetic algorithms for estimating longest path from inherently fuzzy data acquired with GPS, Lecture Notes in Computer Science 4224 (2006) 232-240
- L. Sánchez, I. Couso, Advocating the use of imprecisely observed data in genetic fuzzy systems, IEEE TFS 15 (4) (2007) 551-562
- I. Couso, L. Sánchez, Higher order models for fuzzy random variables, FSS 159(3) (2008) 237-258